

A

		<i>K562</i>	<i>CD34+ PC GM12878</i>	<i>HepG2</i>	<i>Liver</i>	<i>A549</i>	<i>Lung IMR-90</i>	<i>MCF-7</i>	<i>HMEC MCF-10A</i>	<i>HeLa-S3</i>
Transcription Factors TF	TF Total	207	99	95	7	31	1 9	52	2 4	59
	TFSS	129	71	71	6	23	6	37	3	39
	Chromatin Remodeller	17	6	6	1	2	1	2		6
	Cofactor	19	9	11		4		3		4
	General (GTF)	15	7	6		4	1	3	1	9
Histone Modifications HM	Histone	12	6 11	11	7	11	7 28	5	11 3	11
RNA-binding Proteins RP	eCLIP	89		70						
shRNA/siRNA Knockdown KD	TF	85		61				2		
	RBP	234		225						
3D Chromatin Structure 3D	ChIA-PET	3	3	1				4		2
	Hi-C	▲	▲			●	▲	▲	▲	
Chromatin Accessibility DS	DNase-seq	●	▲	●		●	▲	●	▲	●
	STARR-seq	●	▲	▲				●		
Enhancers SS	WGBS	●	▲	●	▲		▲	▲	▲	
	RRBS	●	▲	●	●	●	●	●	●	●
Methylation ME	RNA-seq	●	▲	●	●	●	●	●	▲	●
	RAMPAGE	●	▲	●			●			
Transcription TX	Repli-seq/chip	●	▲	●			●	●		●
	SNV	▲	▲					▲		▲
Replication Timing RT	SV	▲	▲					▲		▲
	Cohort	150	150	82	82	197	197	116	116	
Cell Line WGS WG	Expression	173		373		517		1100		546
		<i>T</i>	<i>N</i>	<i>T</i>	<i>N</i>	<i>T</i>	<i>N</i>	<i>T</i>	<i>N</i>	<i>T</i>
		Blood		Liver		Lung		Breast		Cervix

B

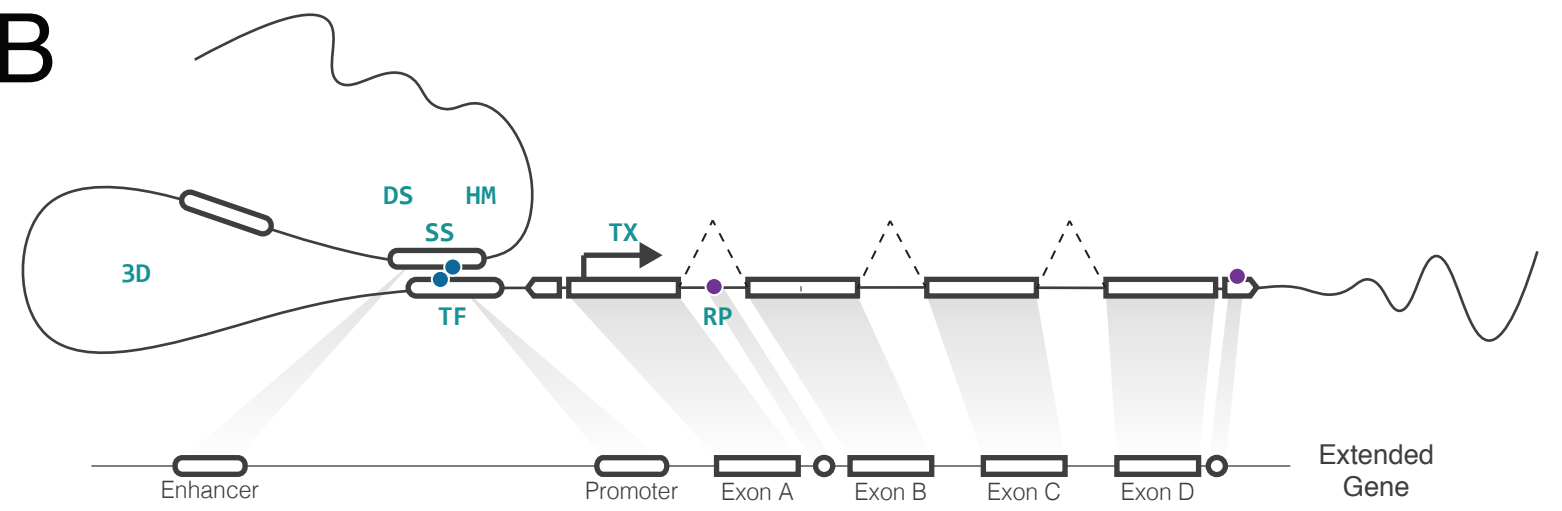

C

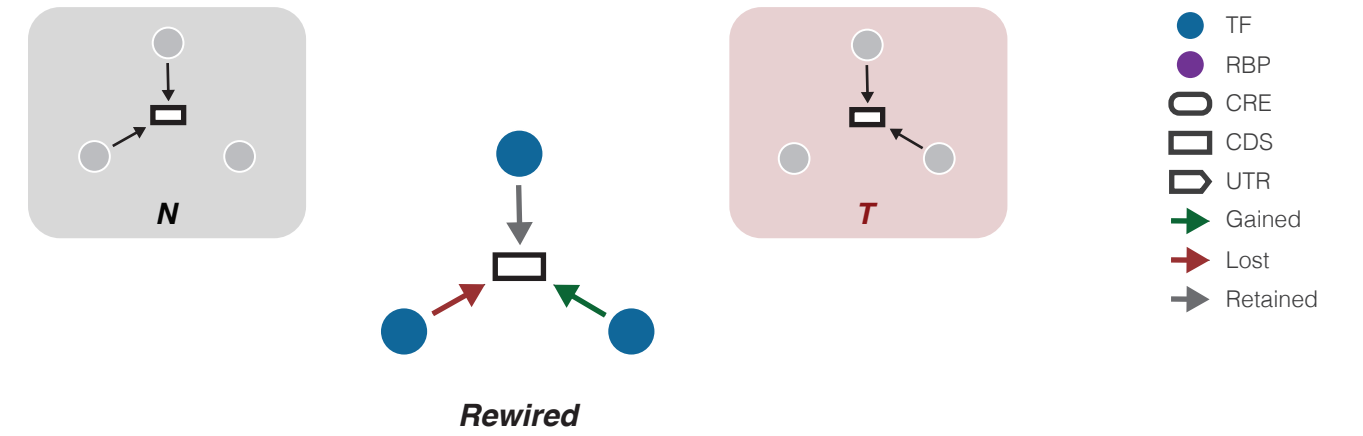

D

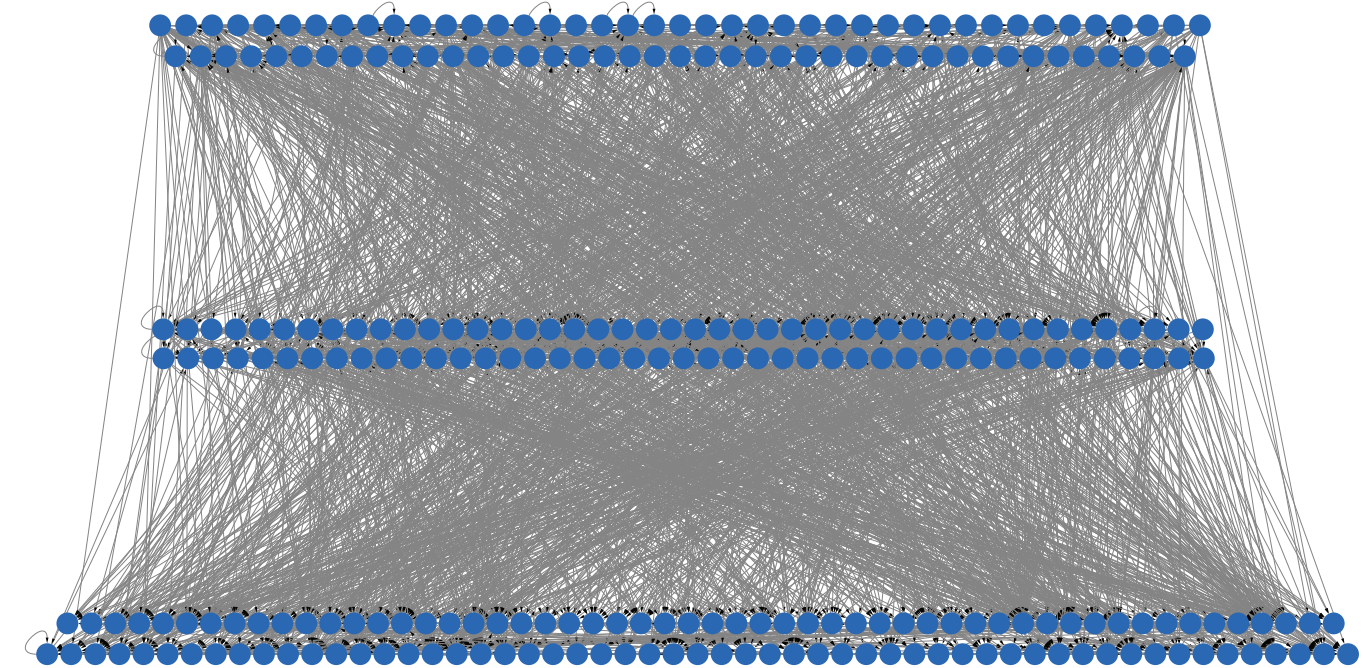

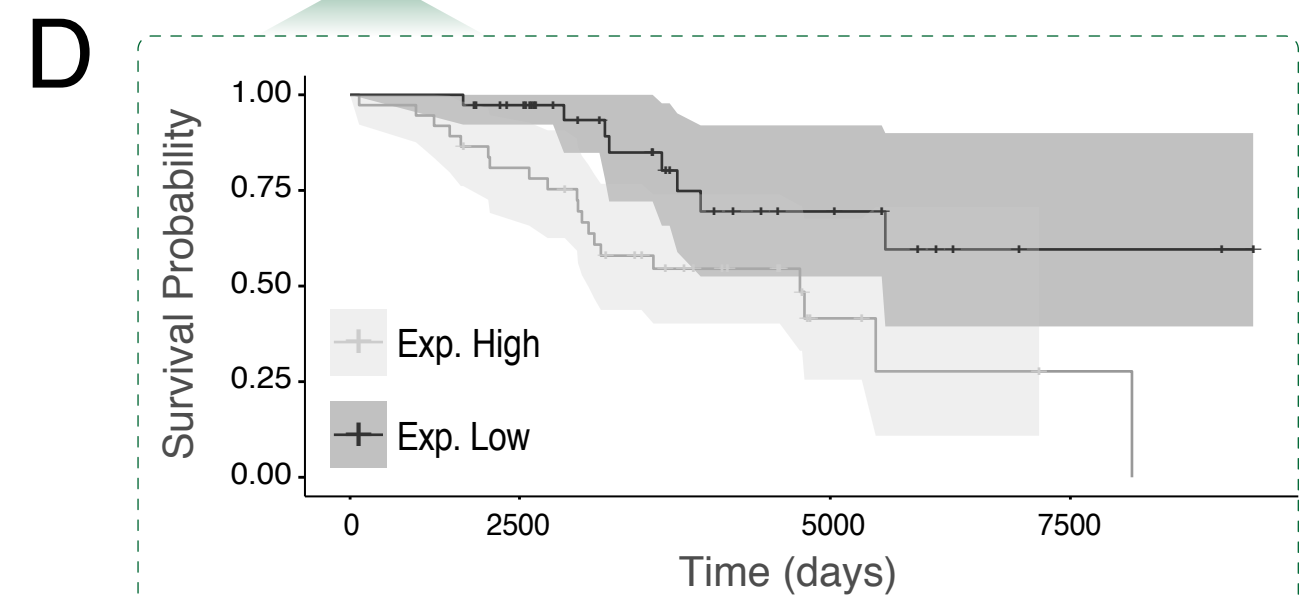
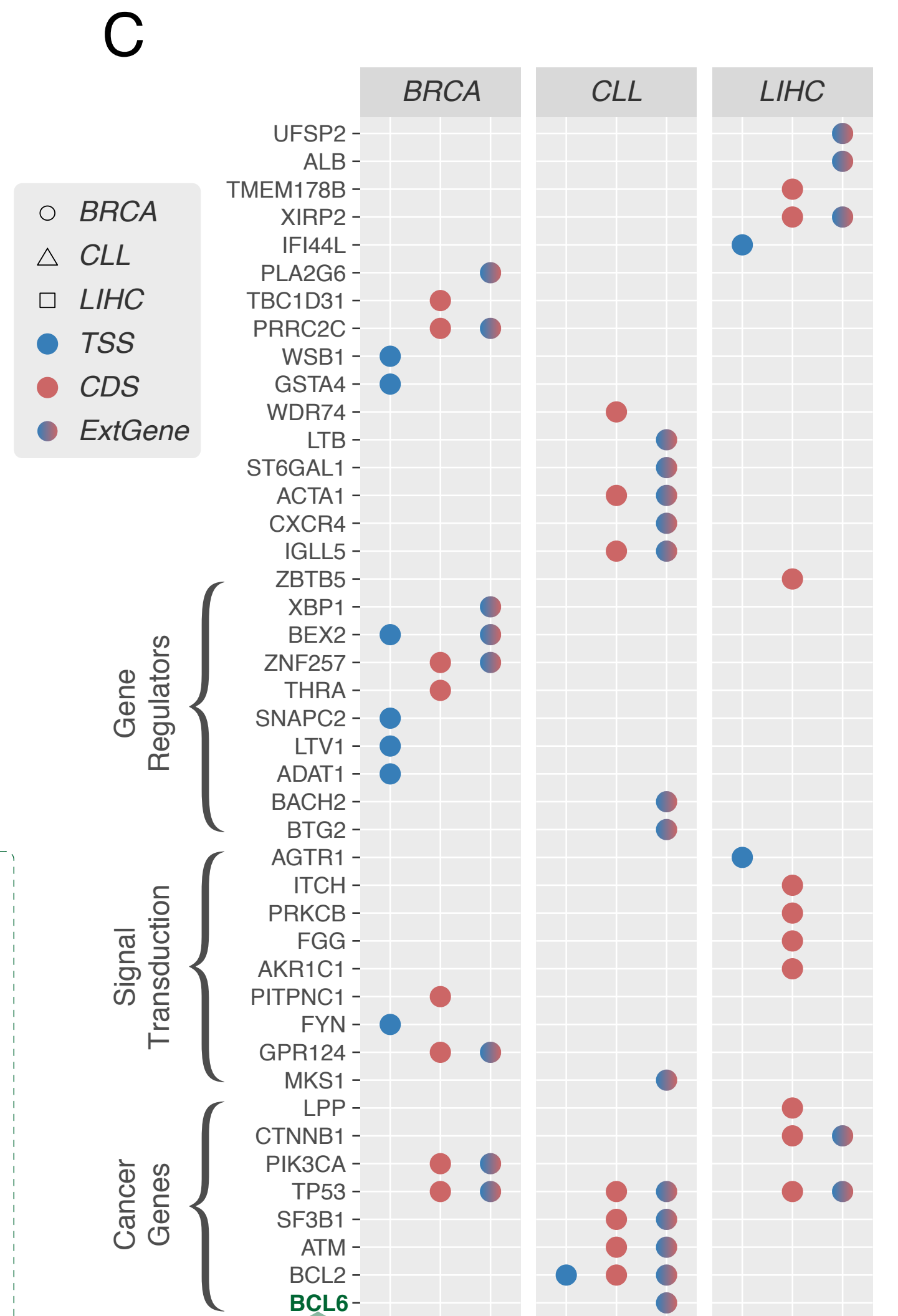
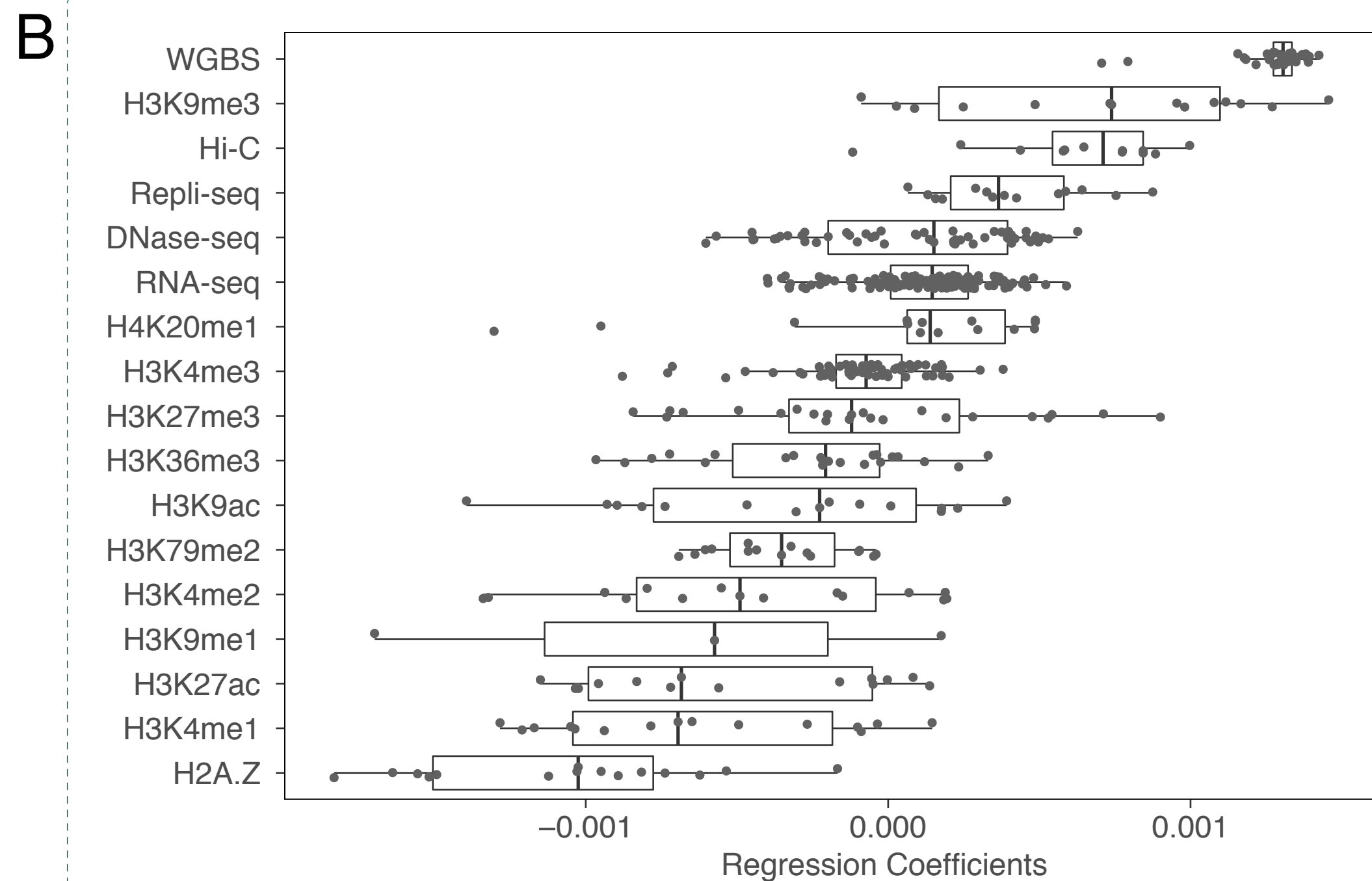
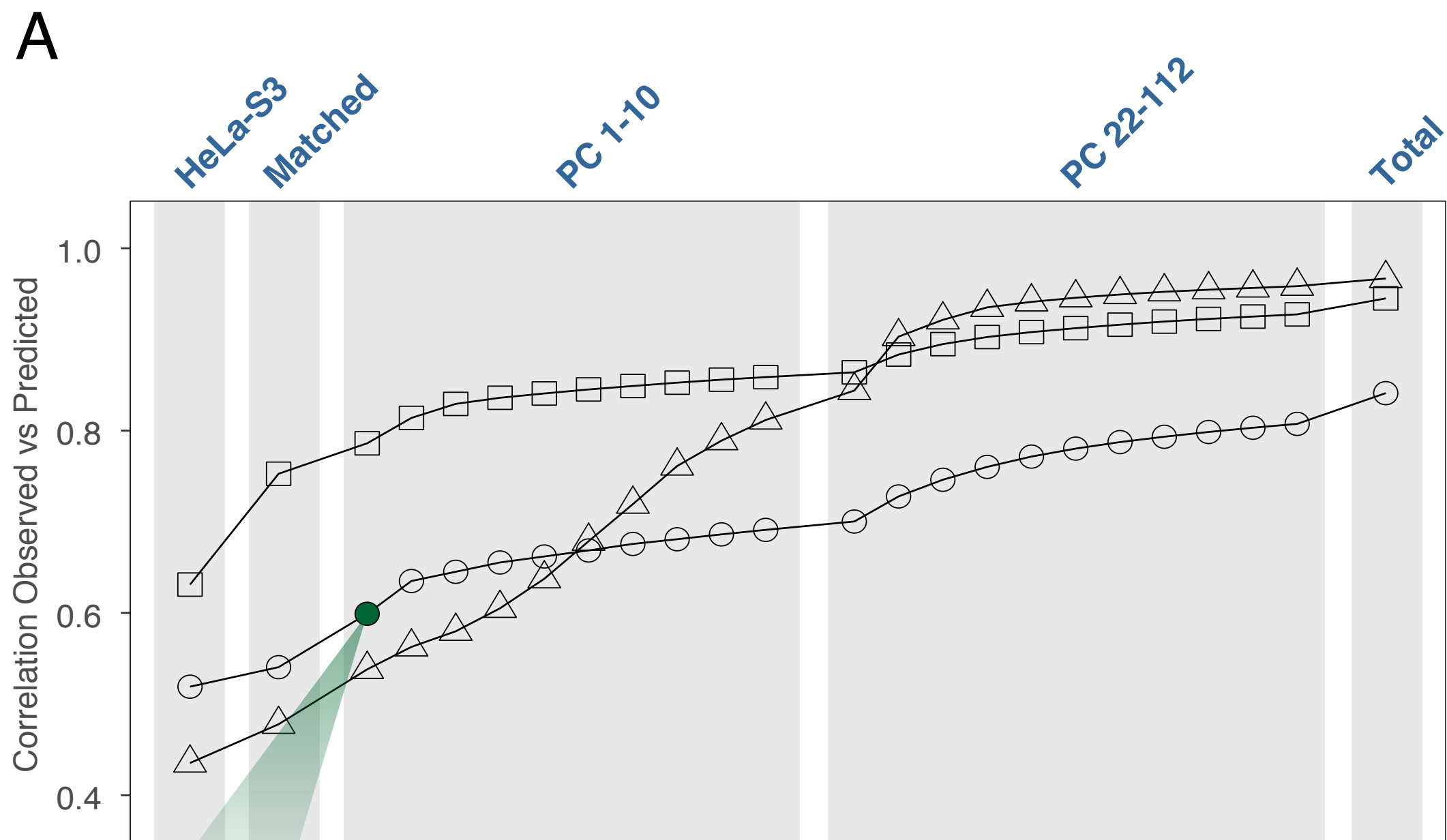

Loser **TF-Gene Network** **Gainer**

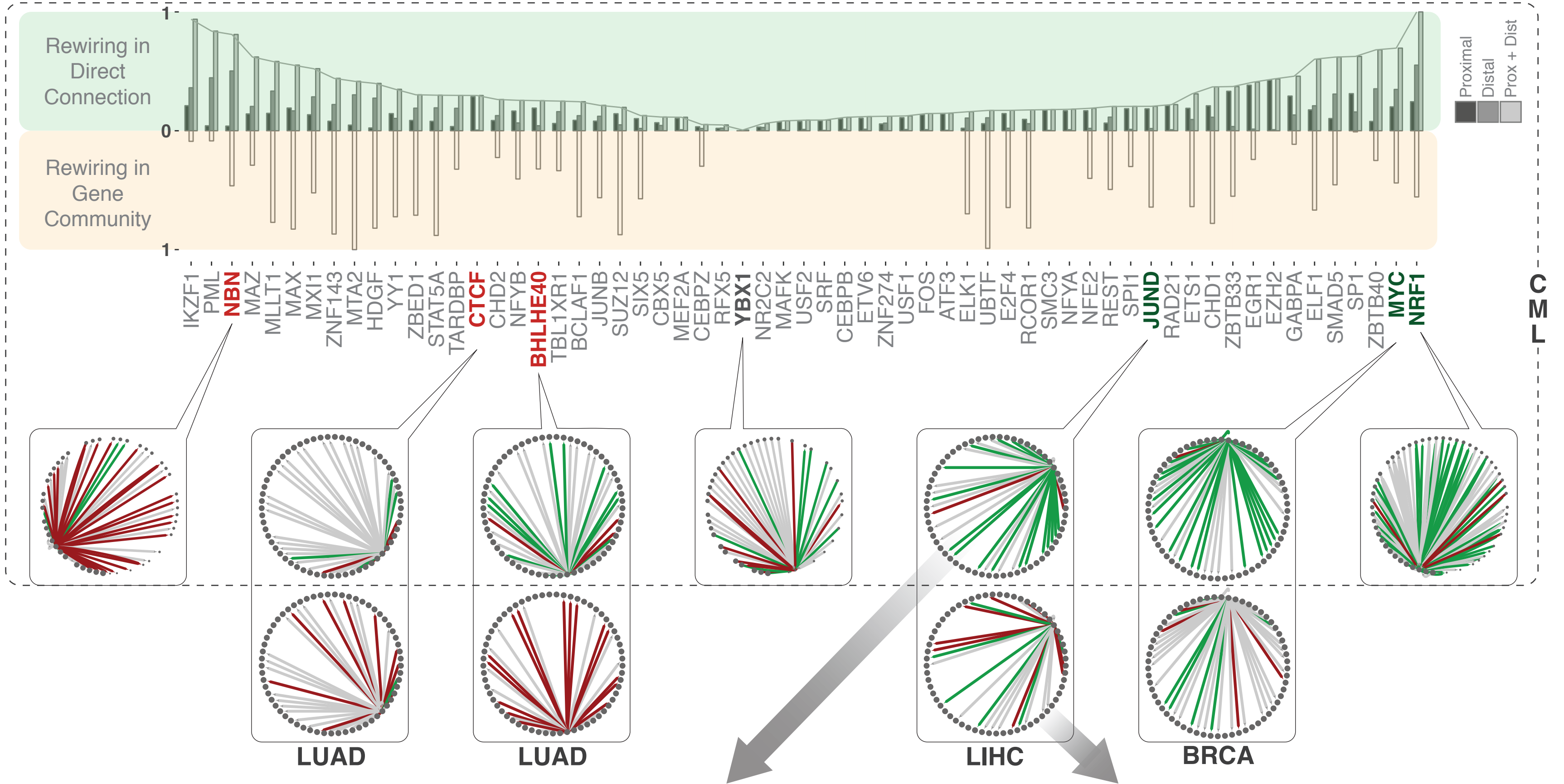

A

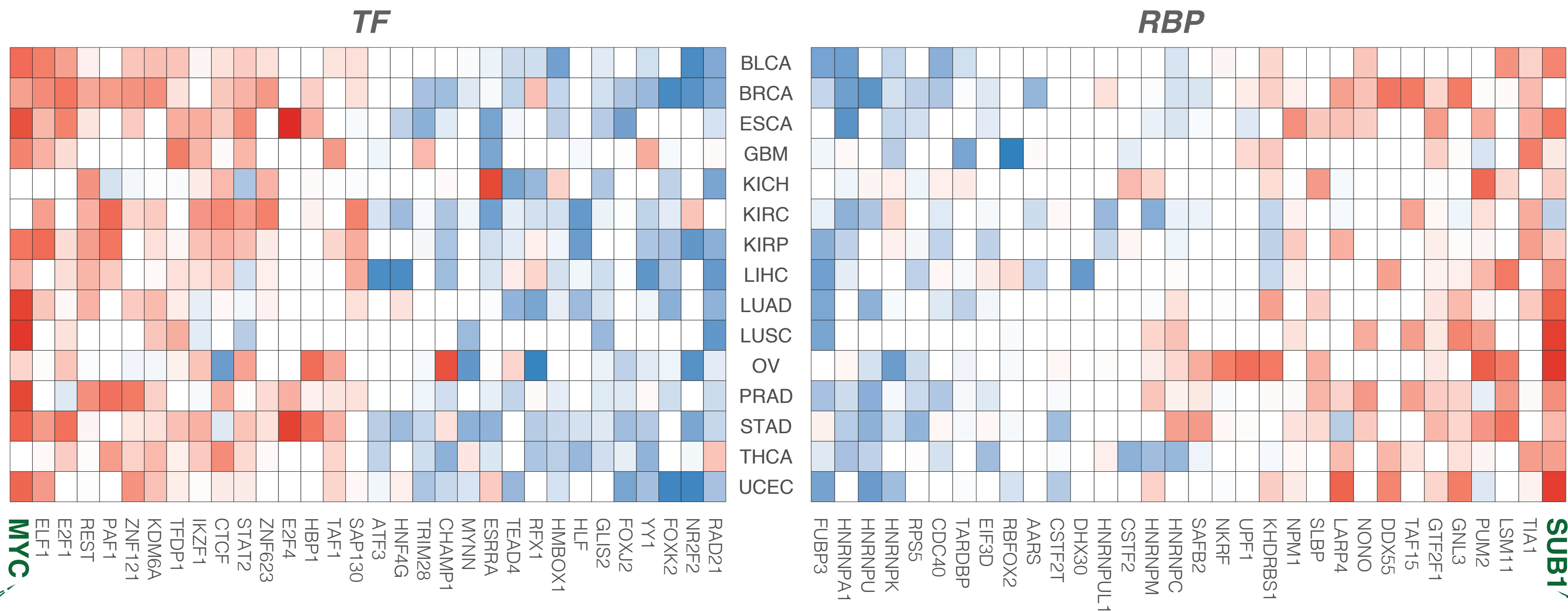

B

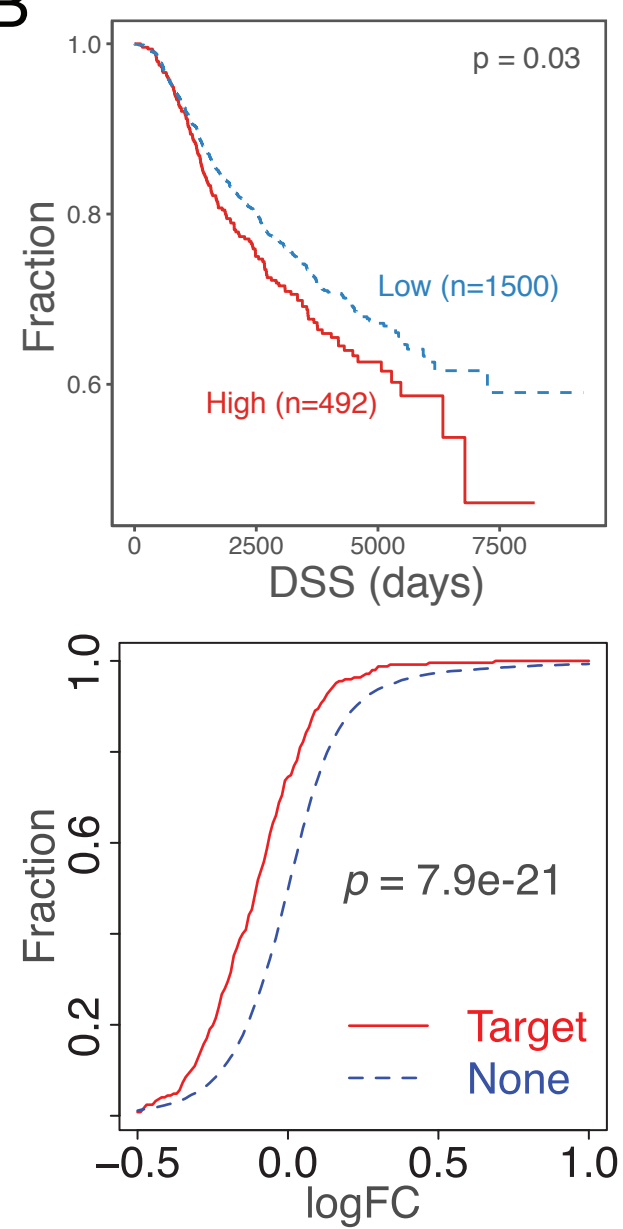

MYC

C(i)

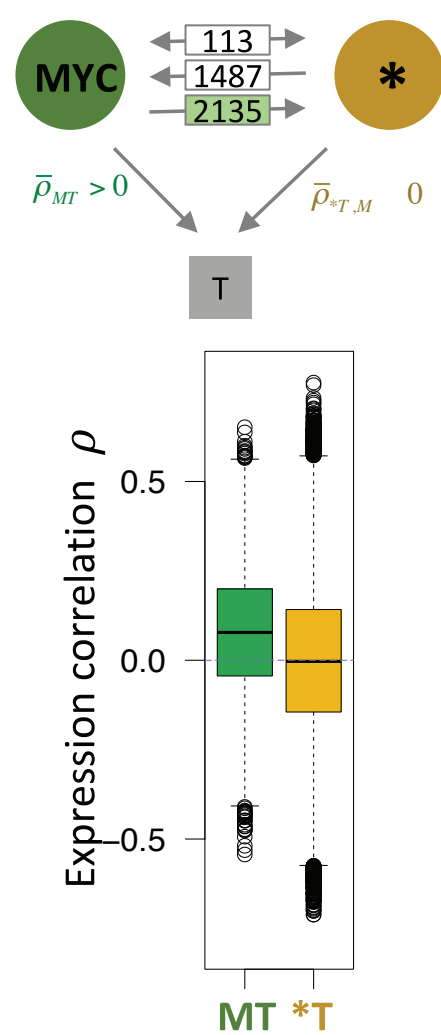

C(ii)

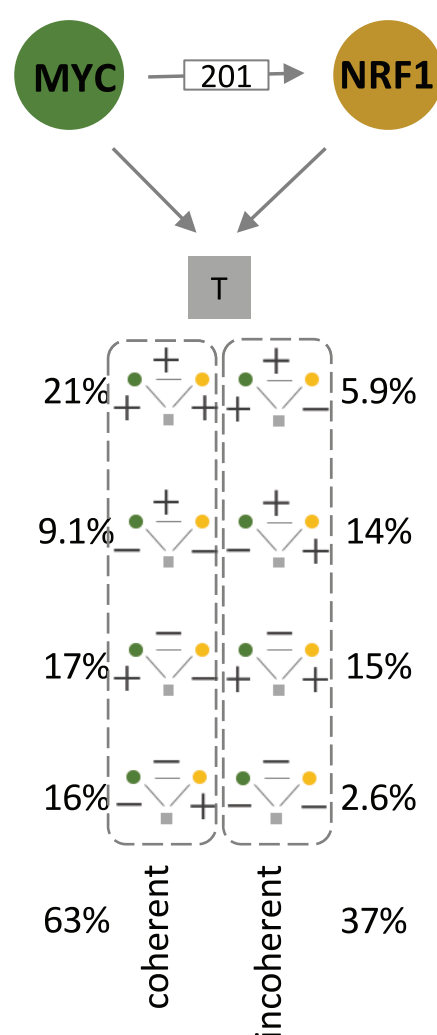

C(iii)

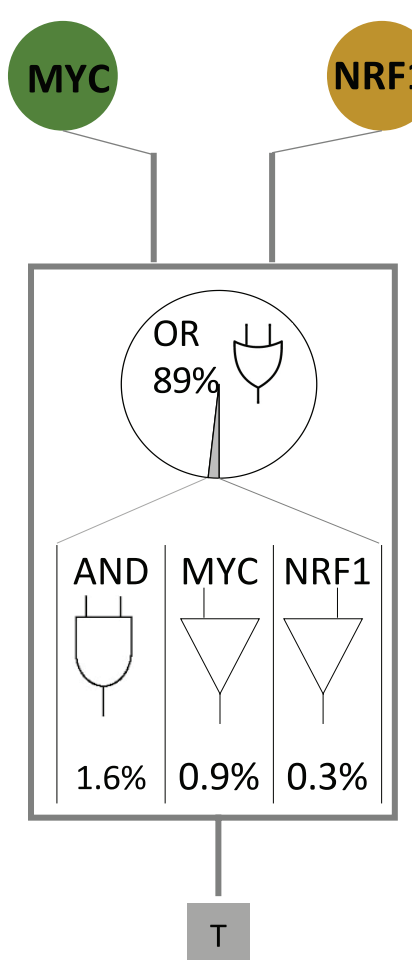

D

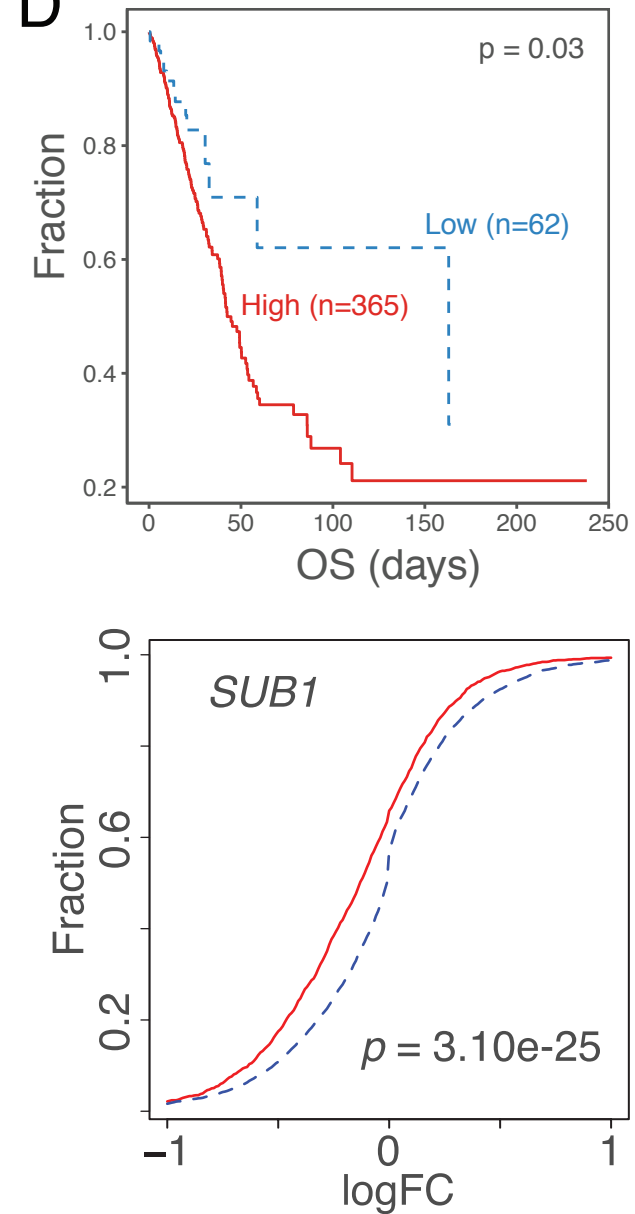

SUB1

