

# MAIN FIGURES

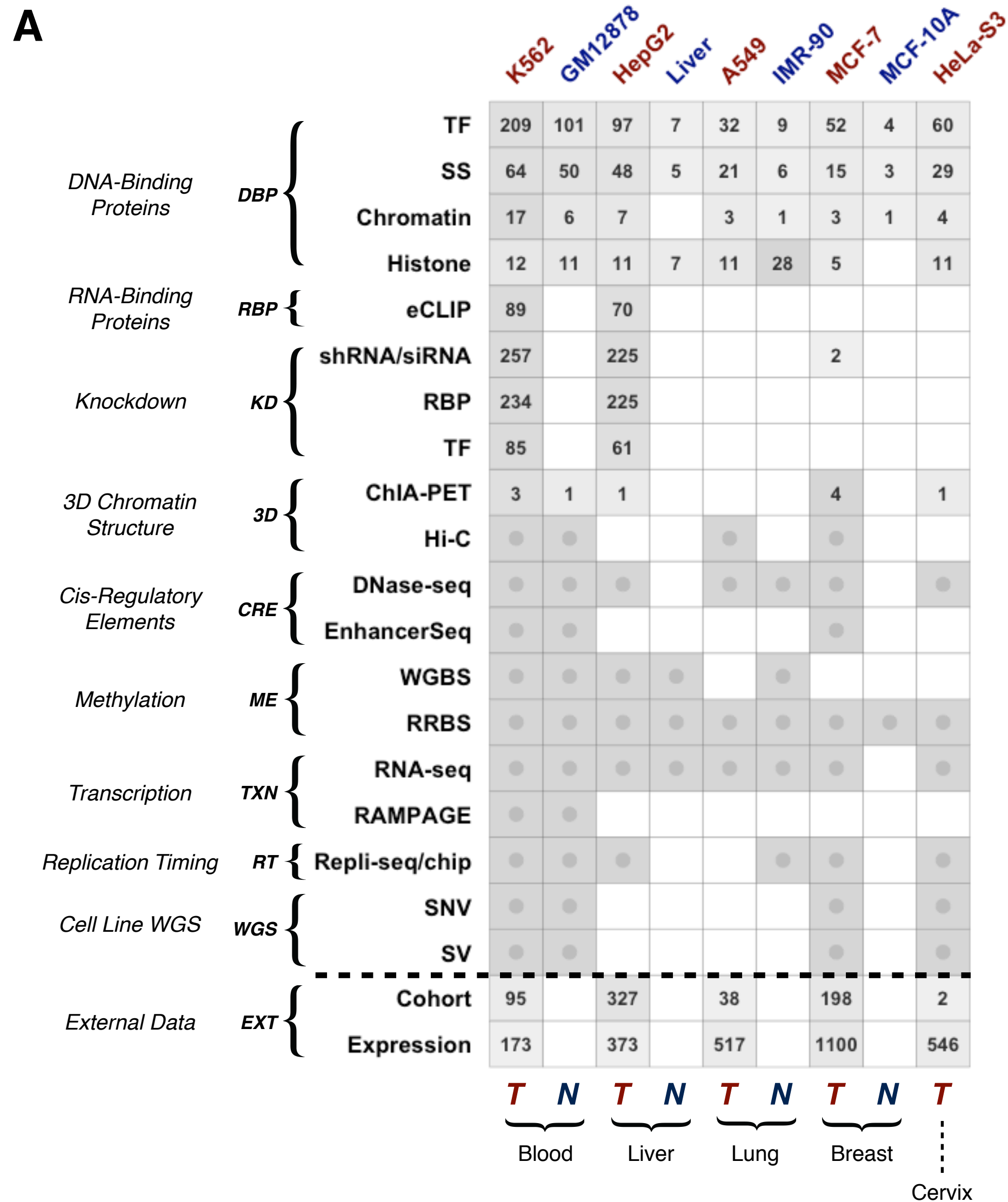

**\*Cohort:**  
 K562::CLLE, HepG2::LIHC, A549::LUAD, MCF-7::BRCA, HeLa-S3::CESC  
**\*\*TCGA (1/28/2016):**  
 K562::LAML, HepG2::LIHC, A549::LUAD, MCF-7::BRCA, HeLa-S3::CESC  
**+SS:** Sequence Specific  
**++Chromatin:** Chromatin Remodeler  
 (For more information, see supplementary data table)

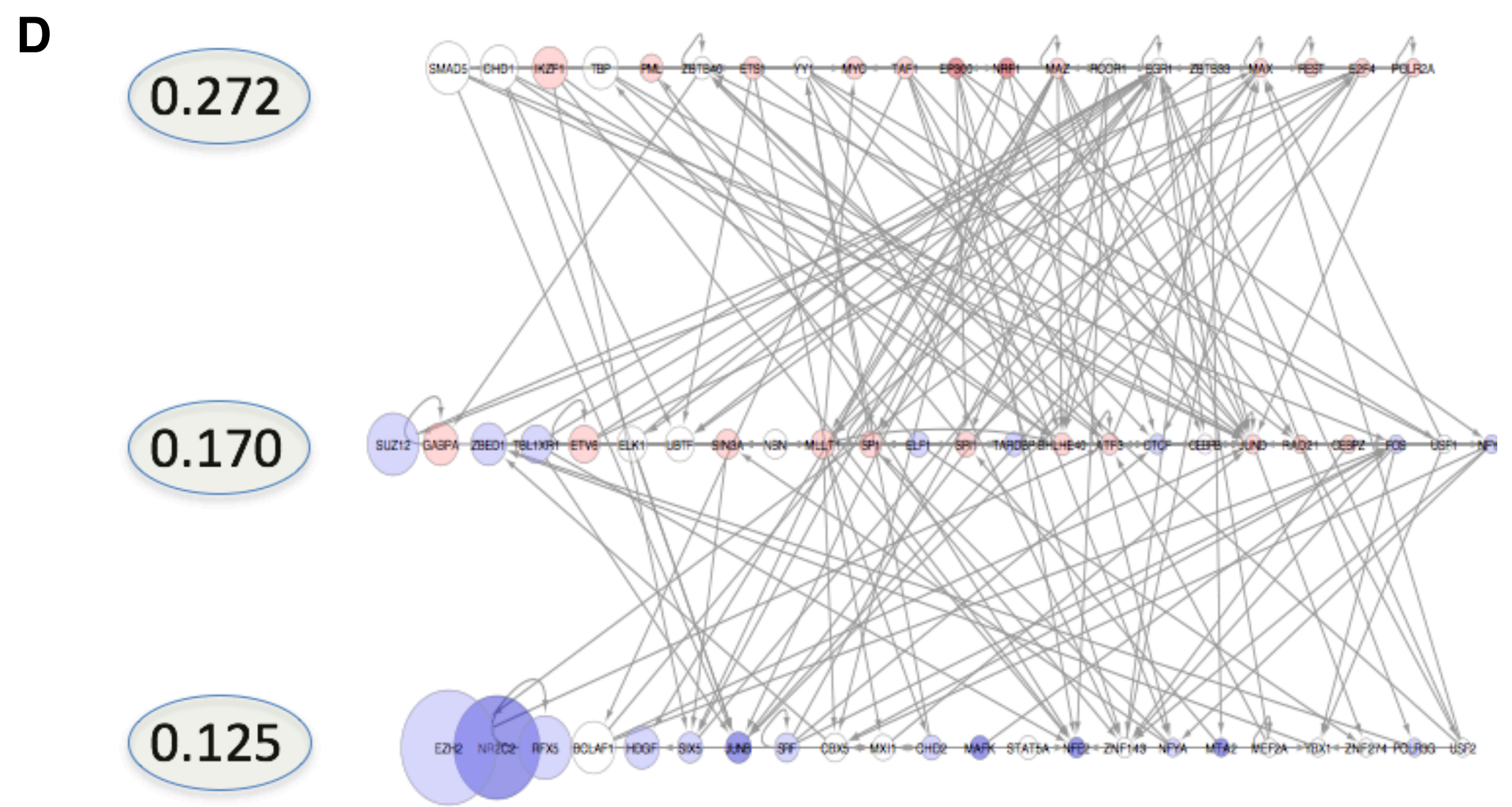
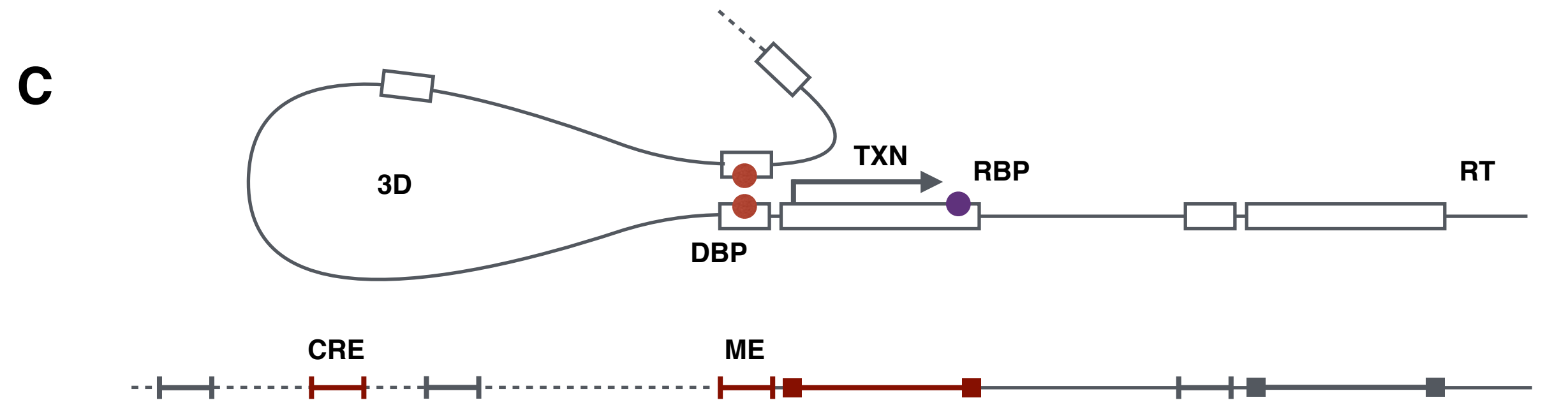
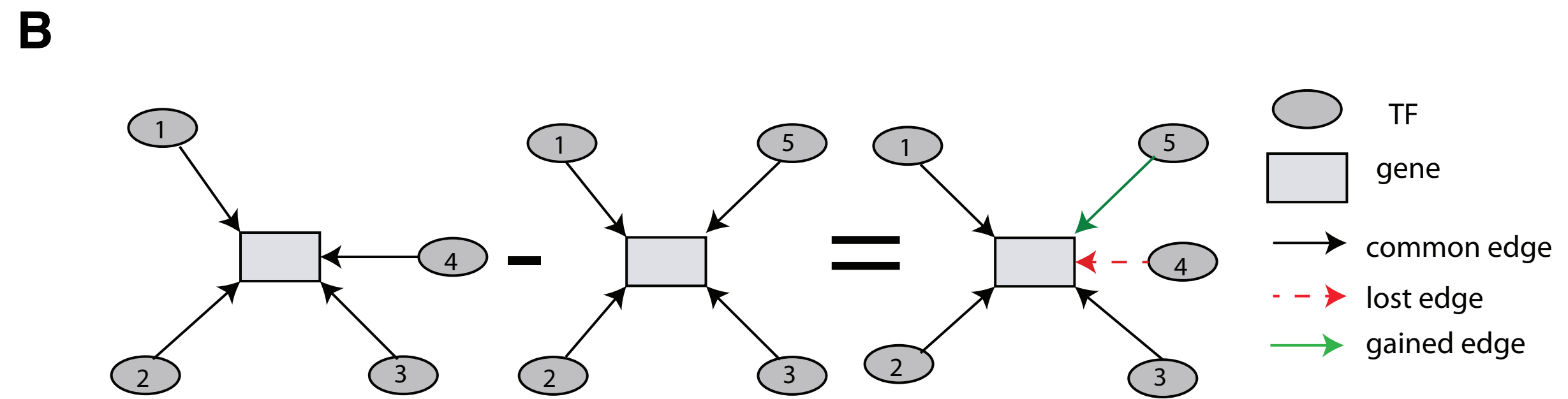

**Figure 1**

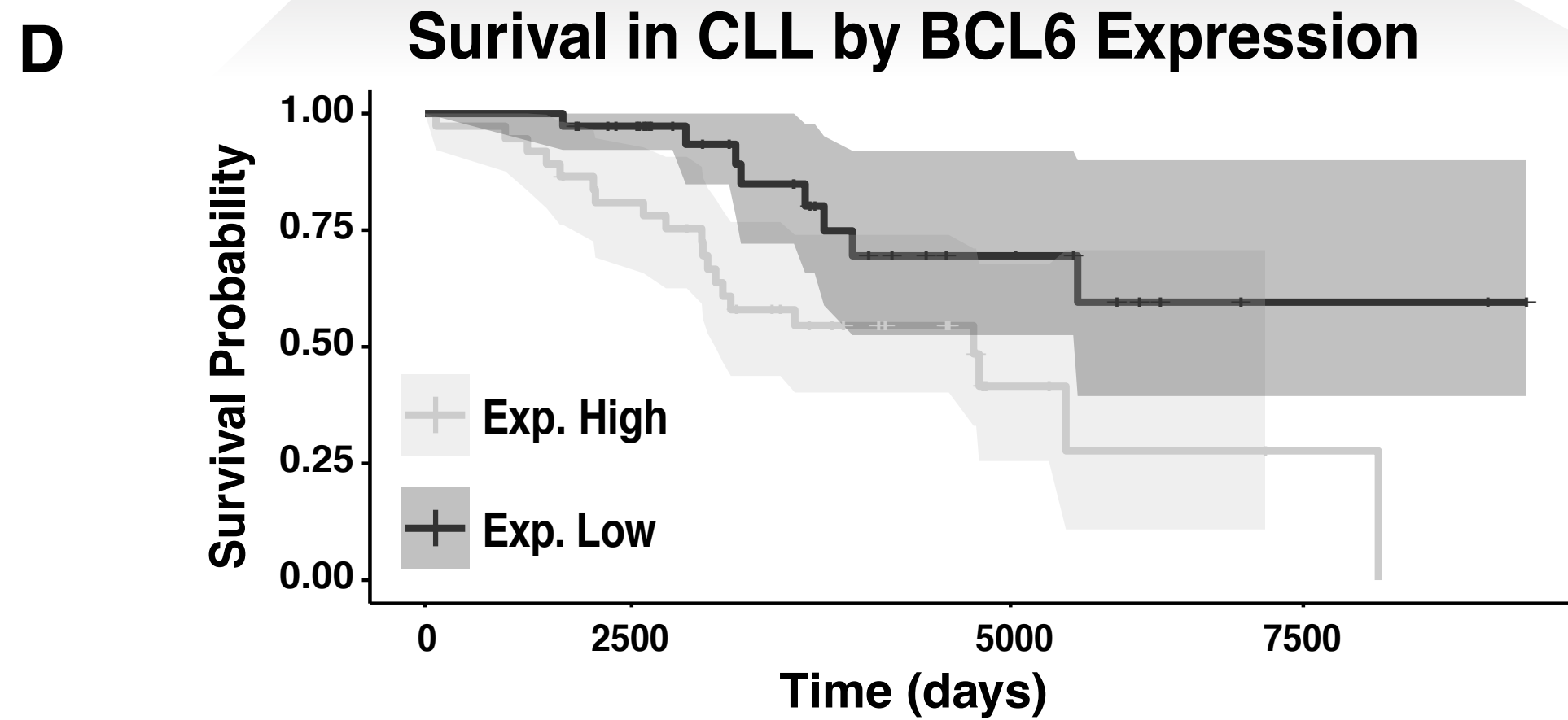
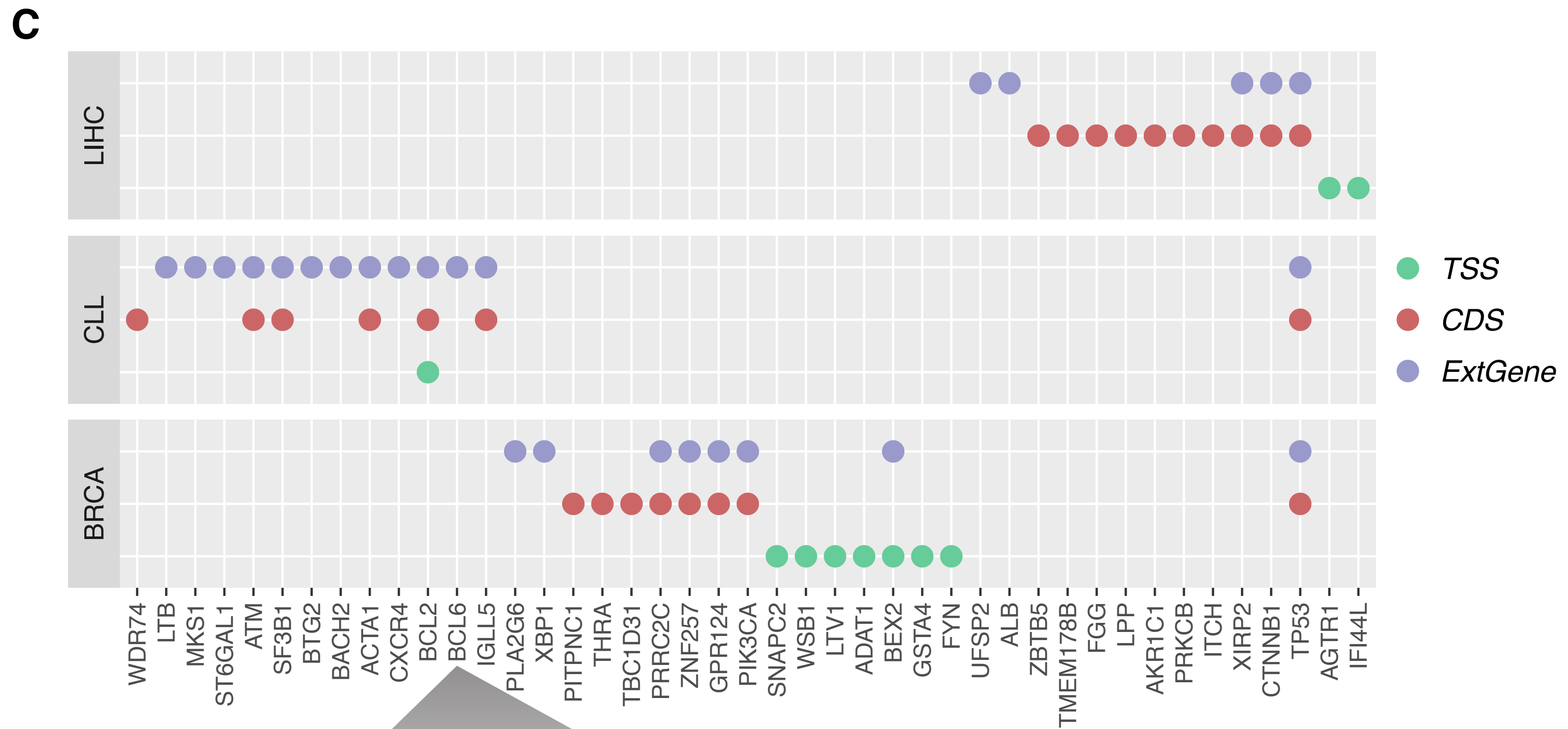
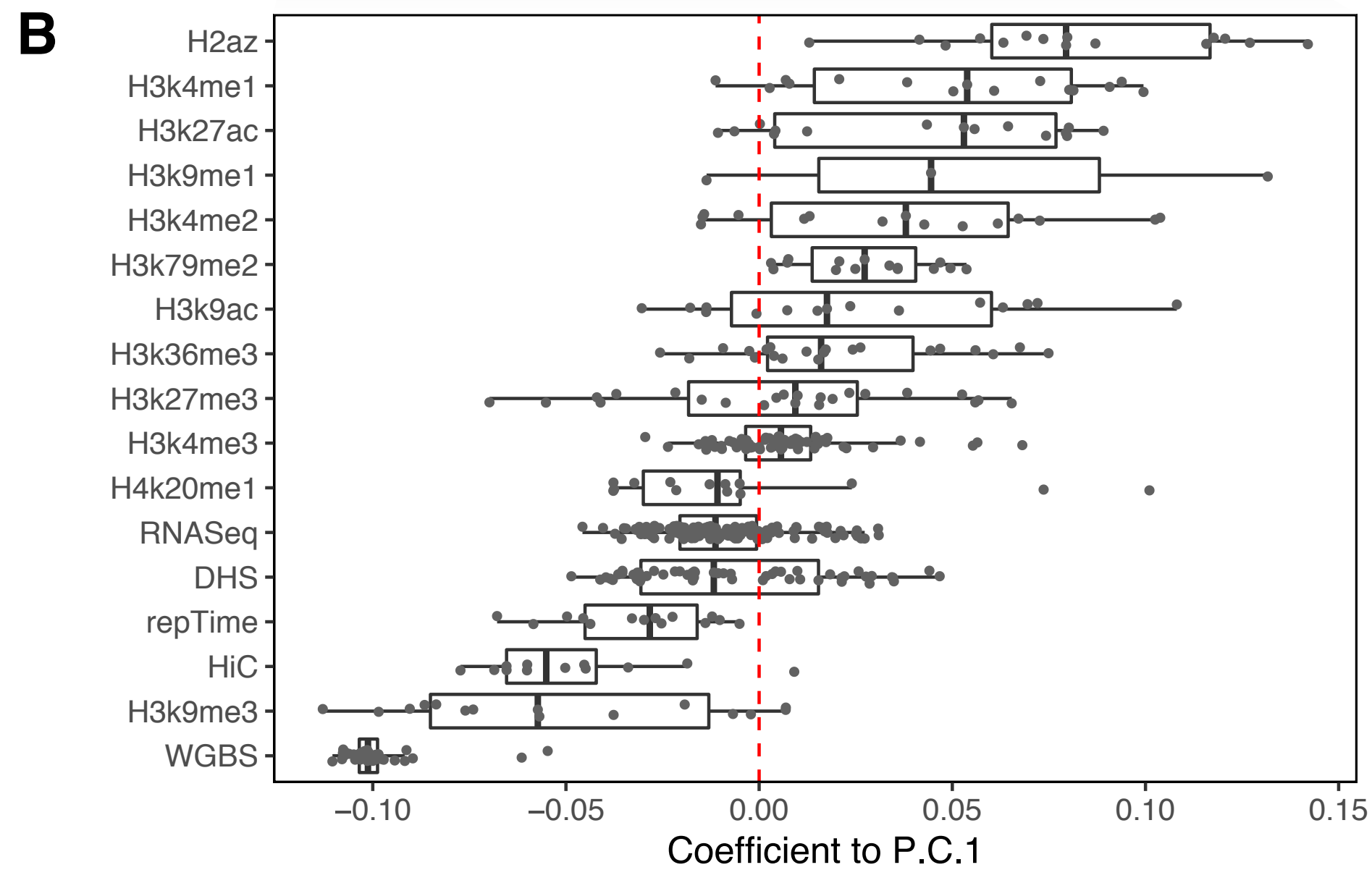
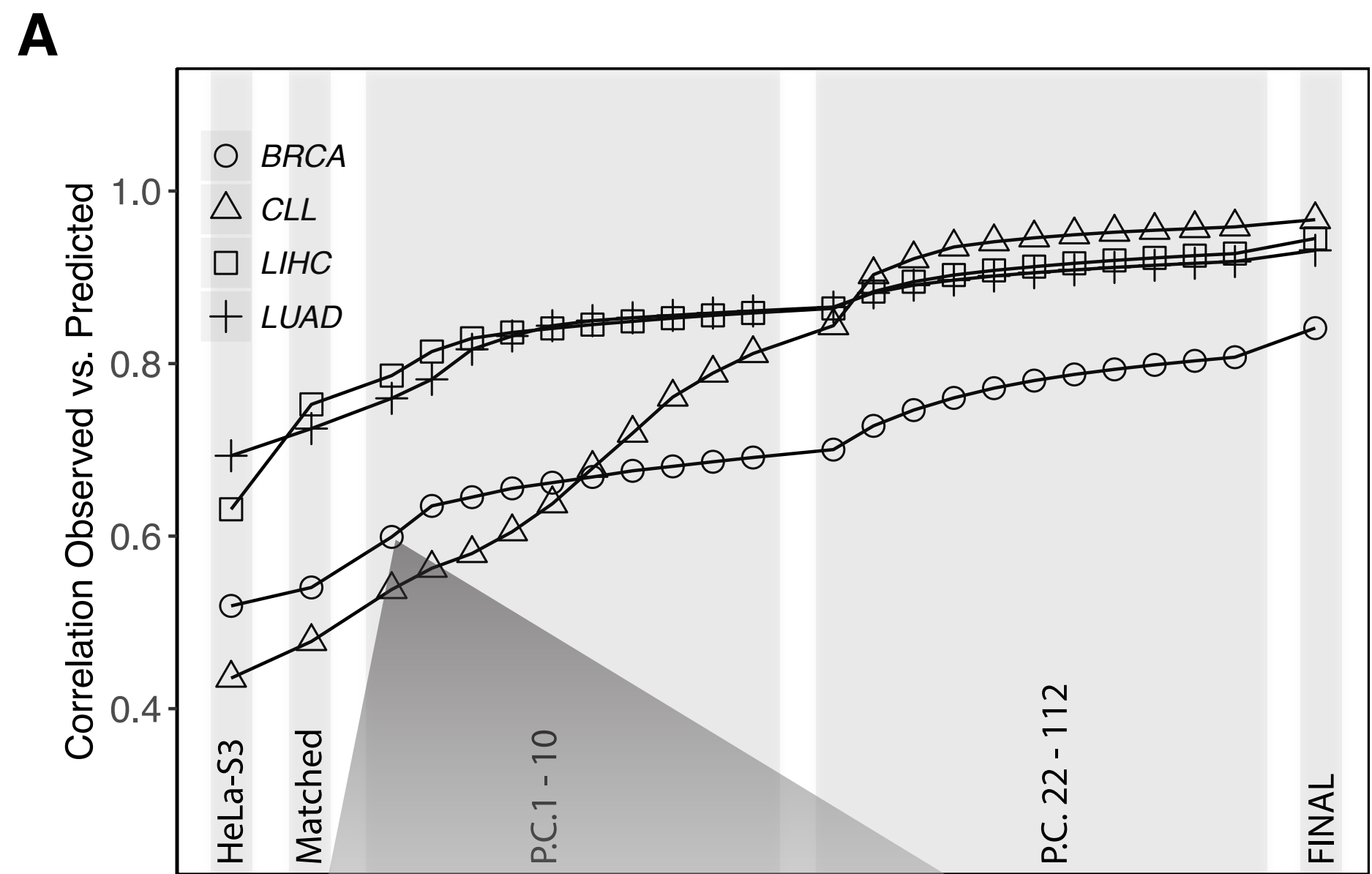

**Figure 2**

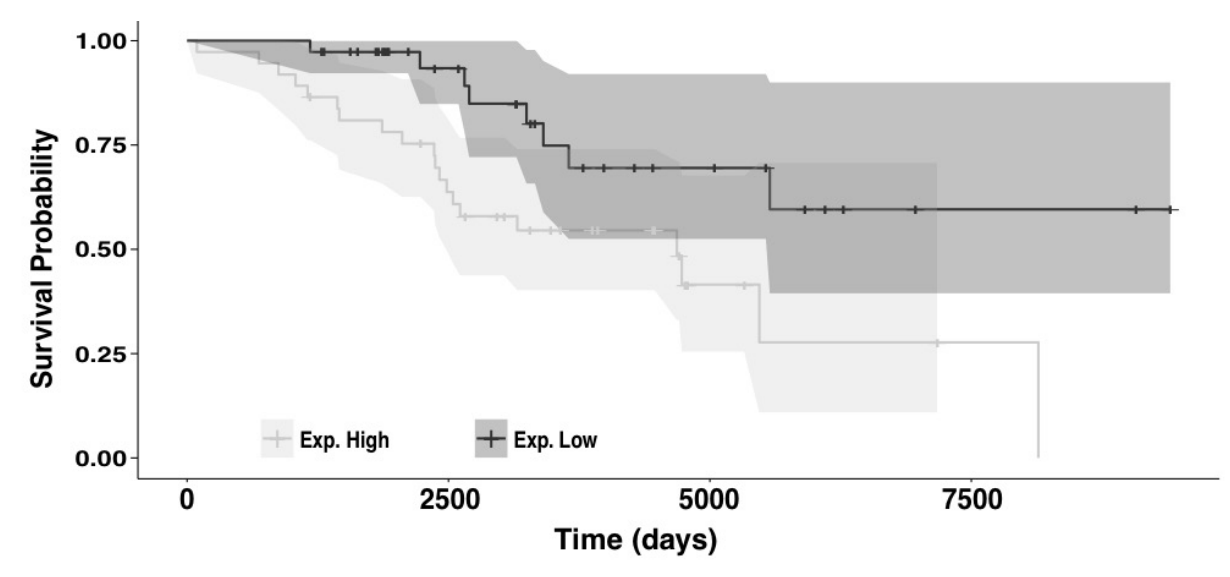
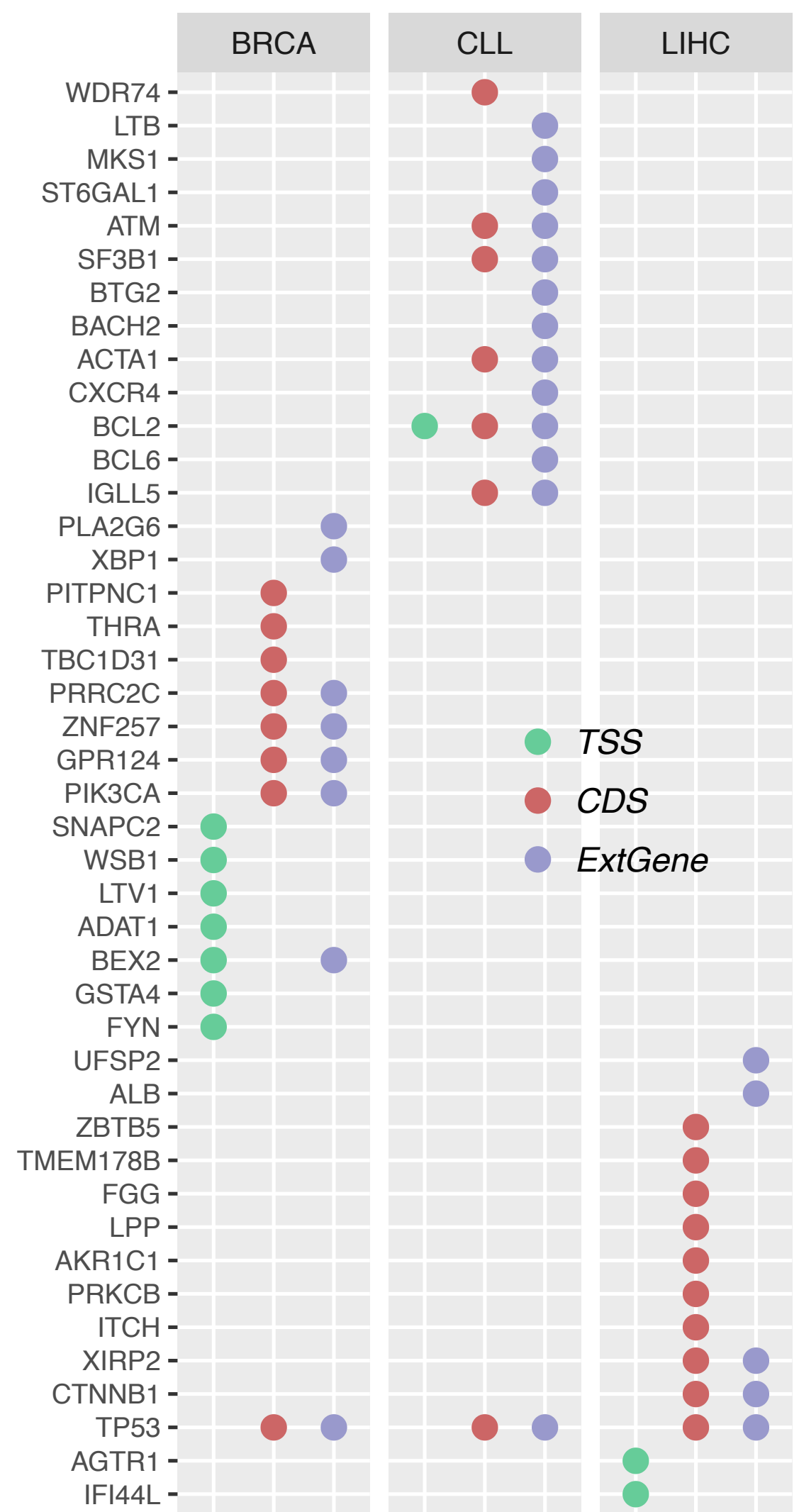
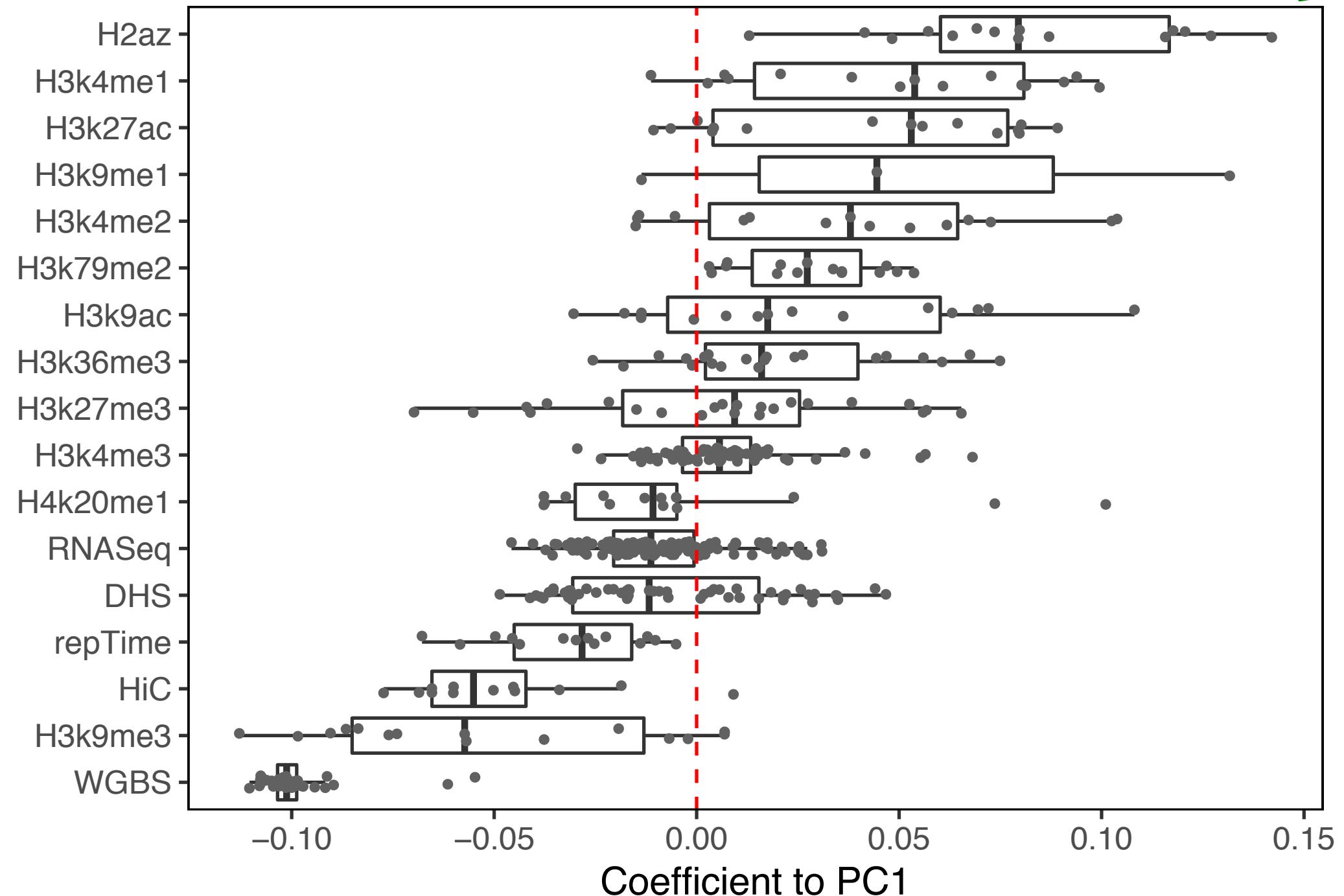
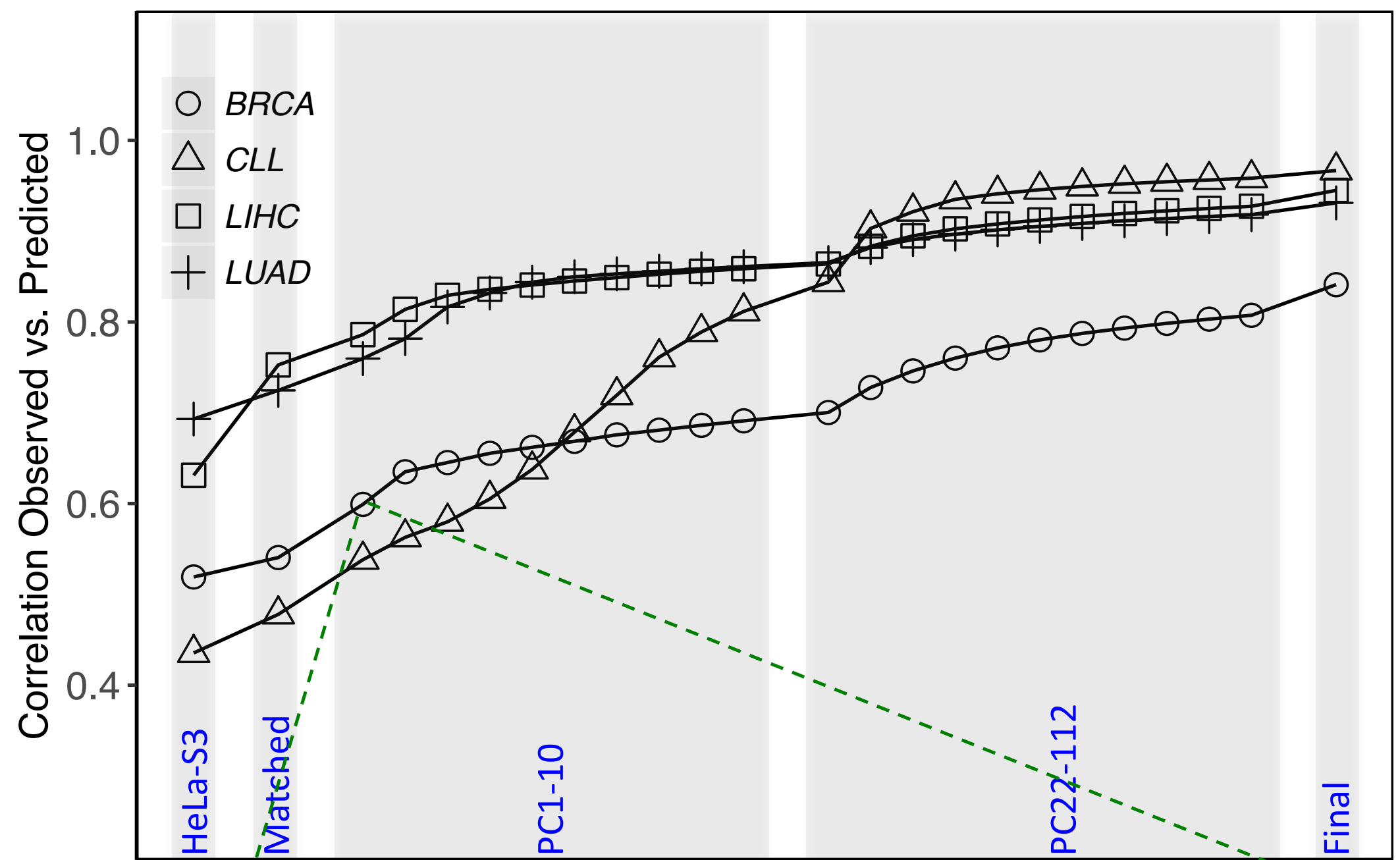

**Figure 2**

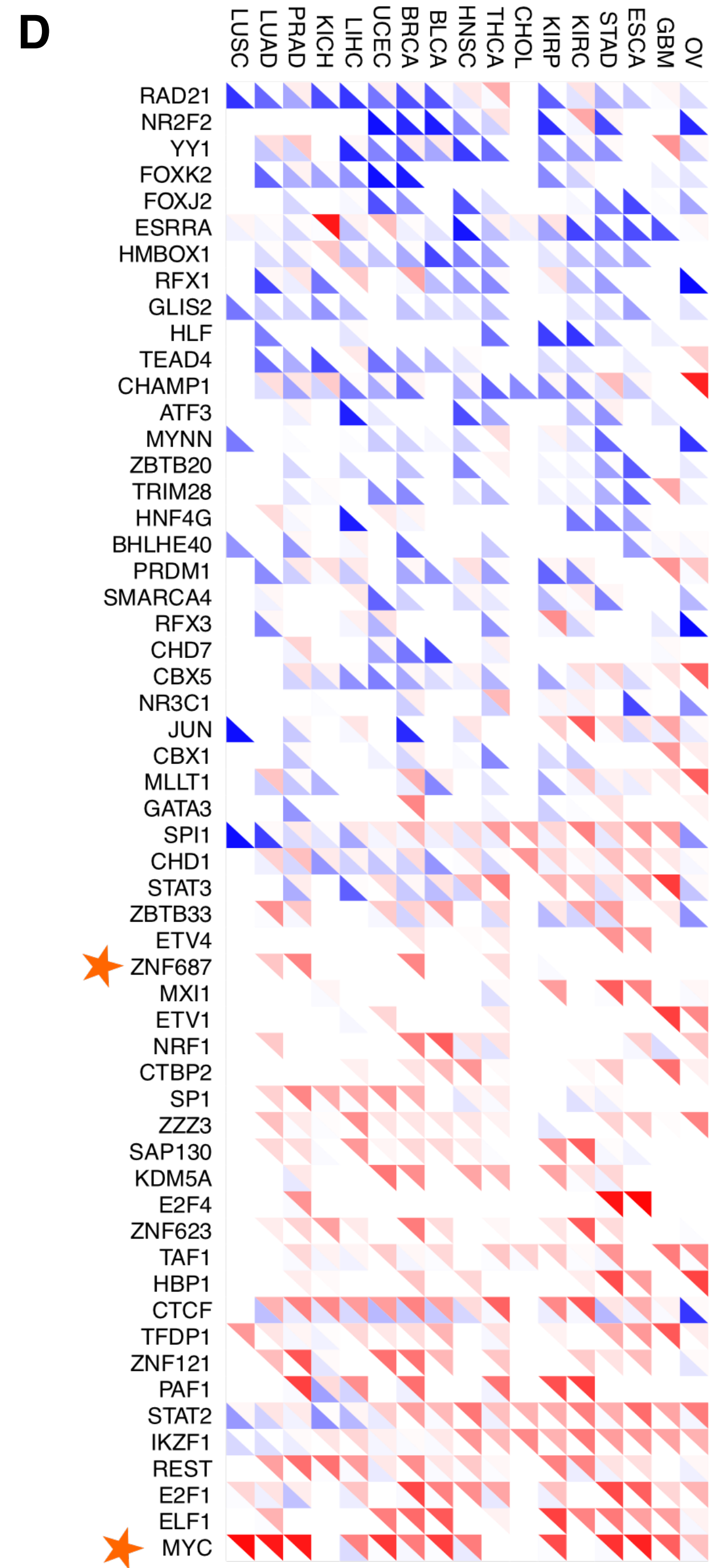
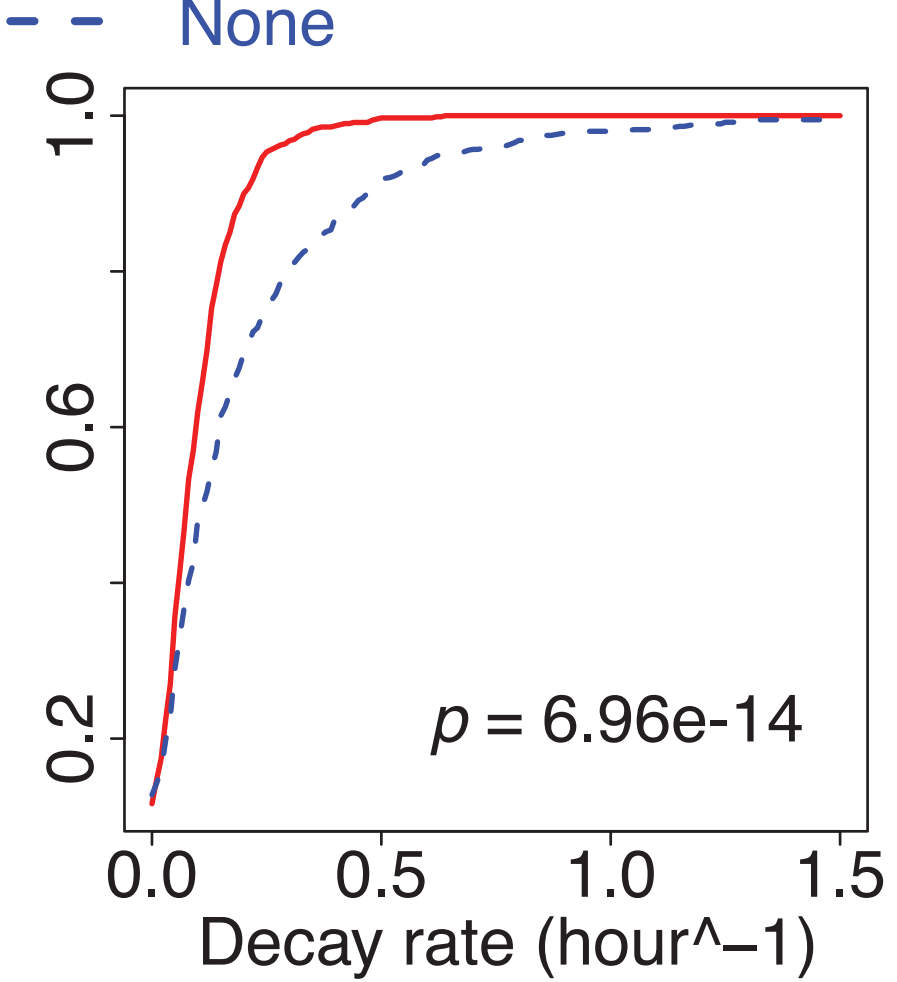
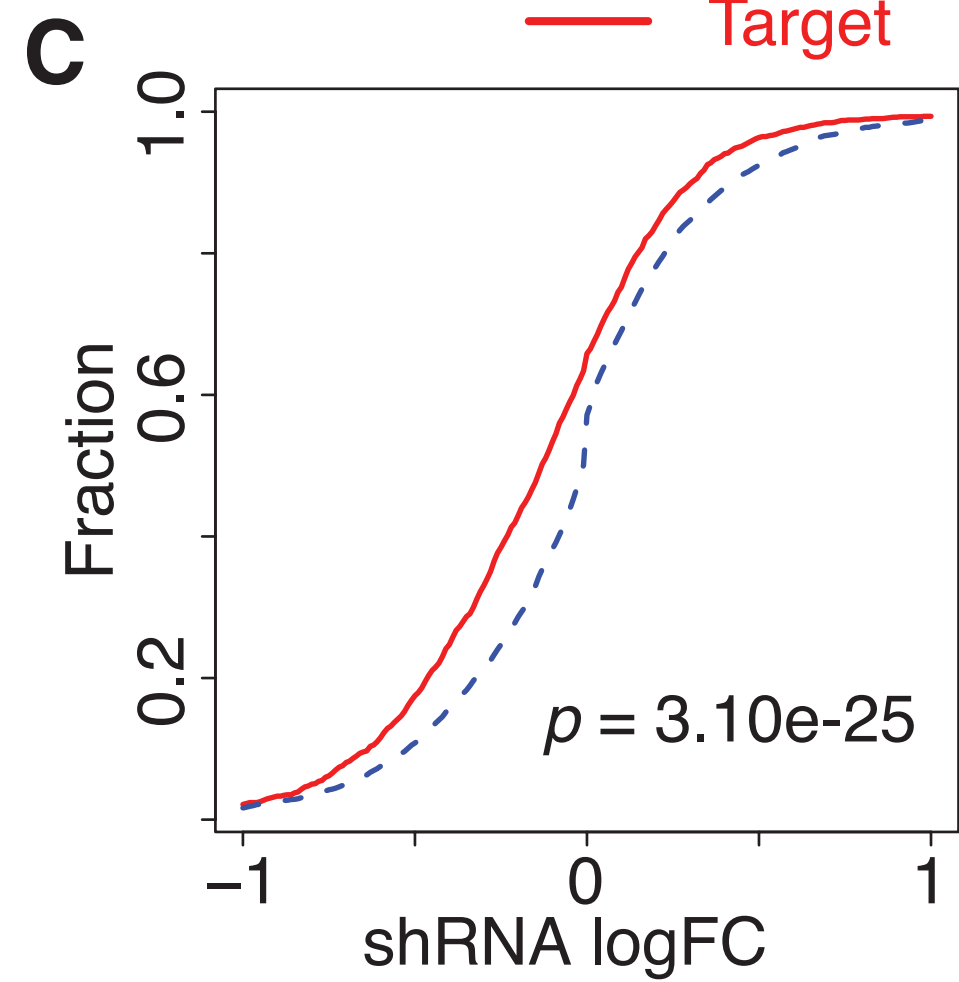
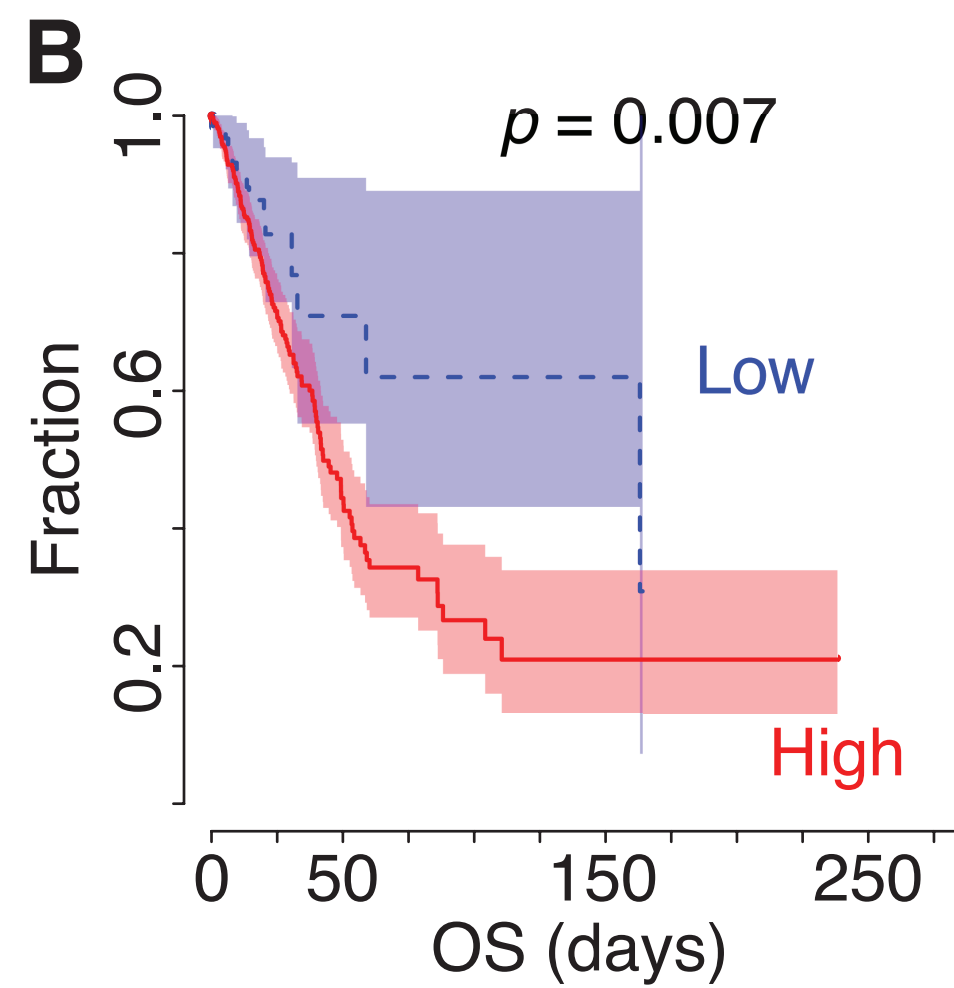
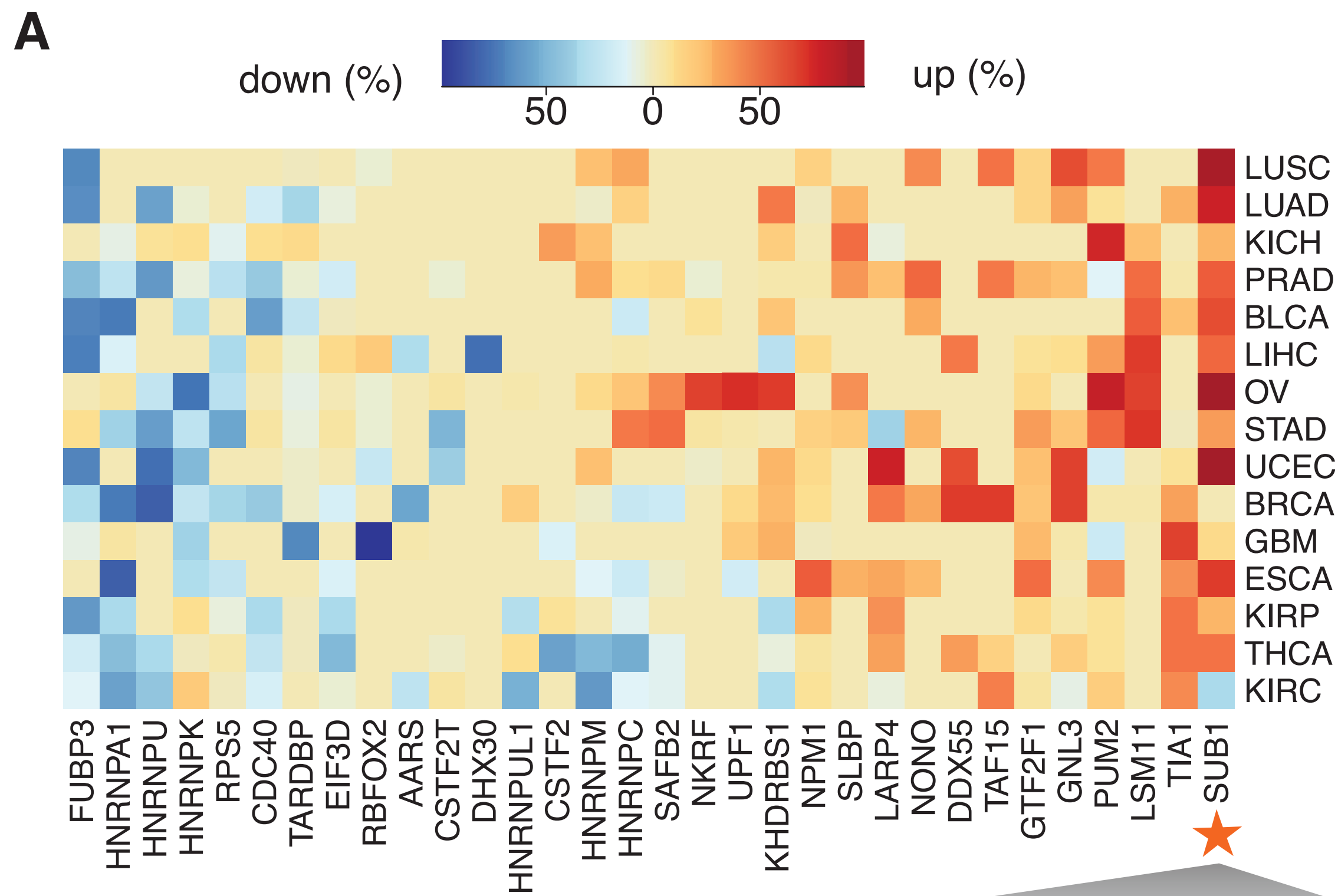

**Figure 3**

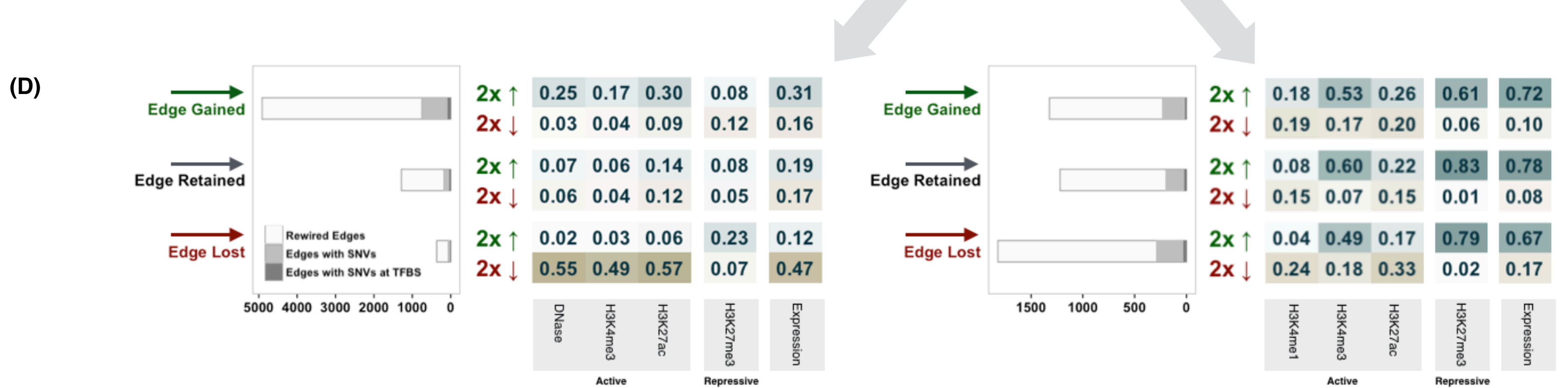
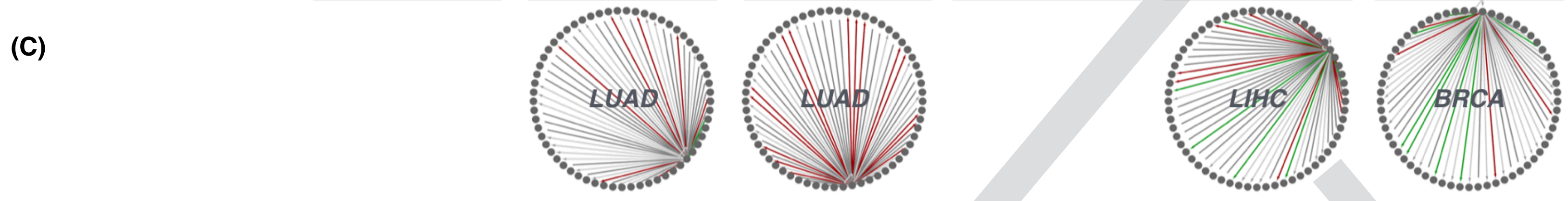
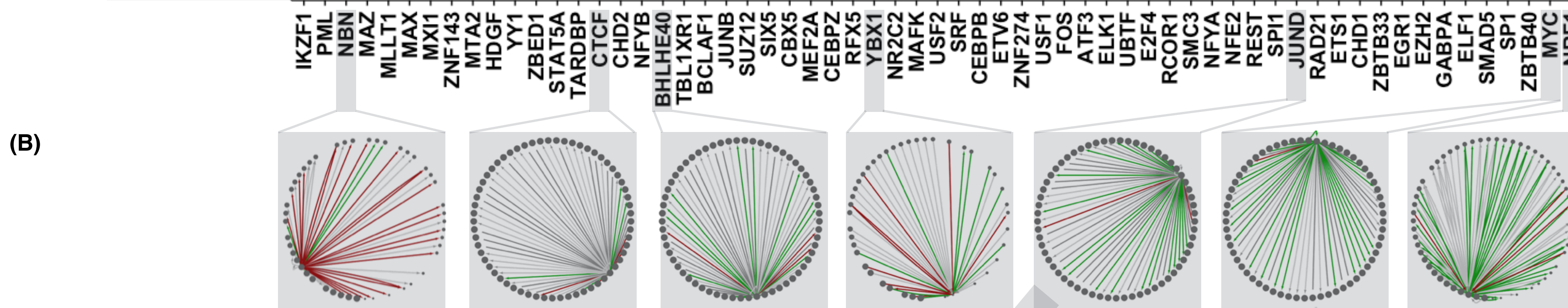
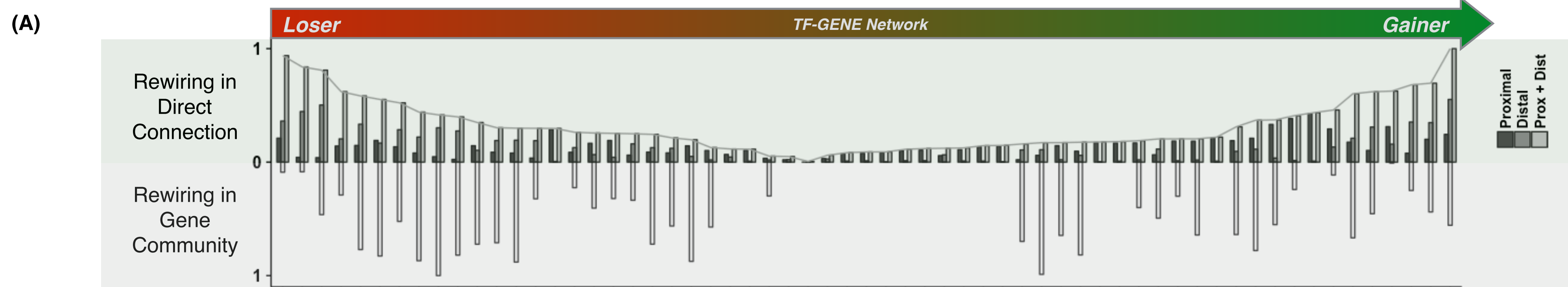

**Figure 4**

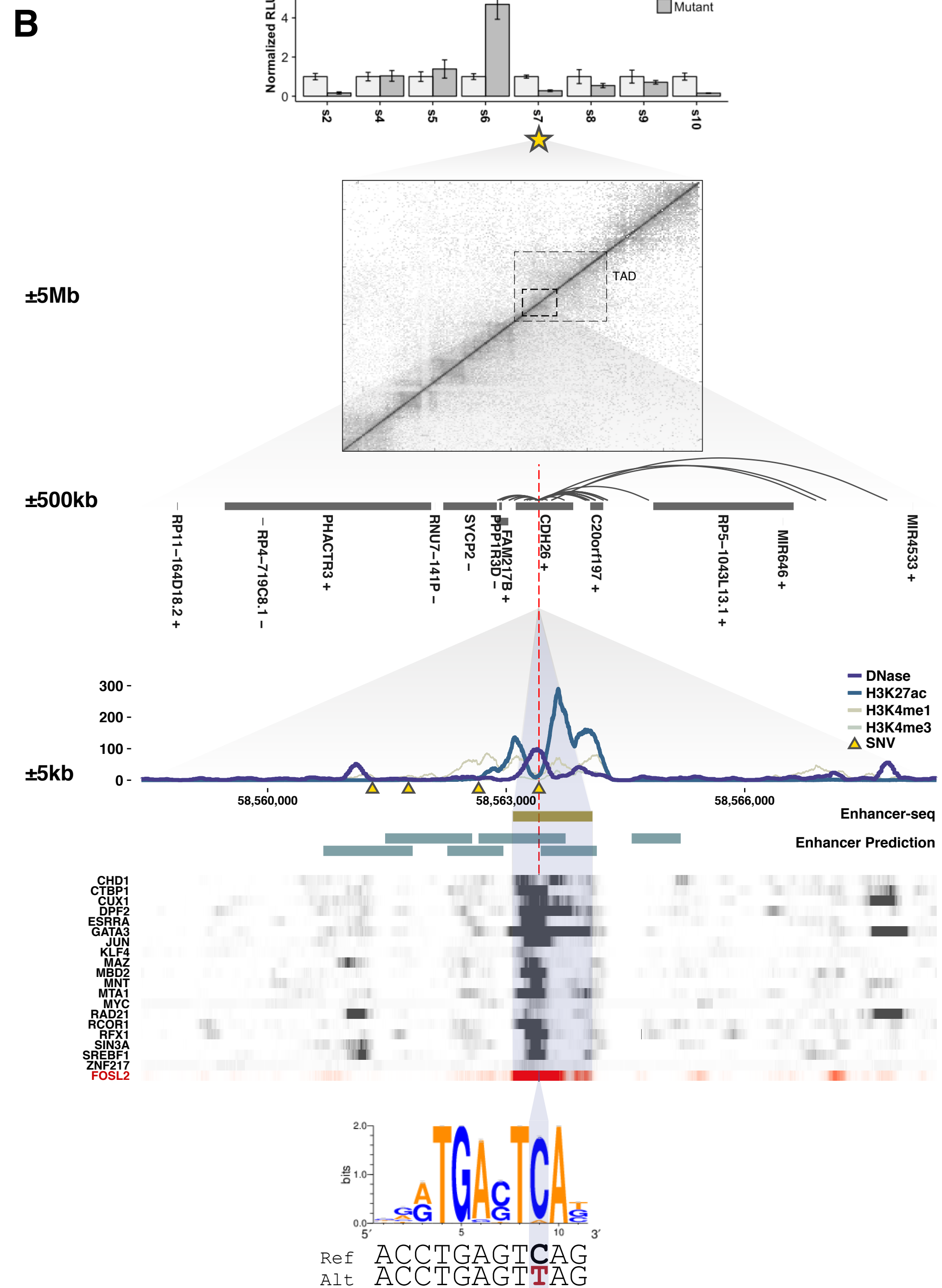
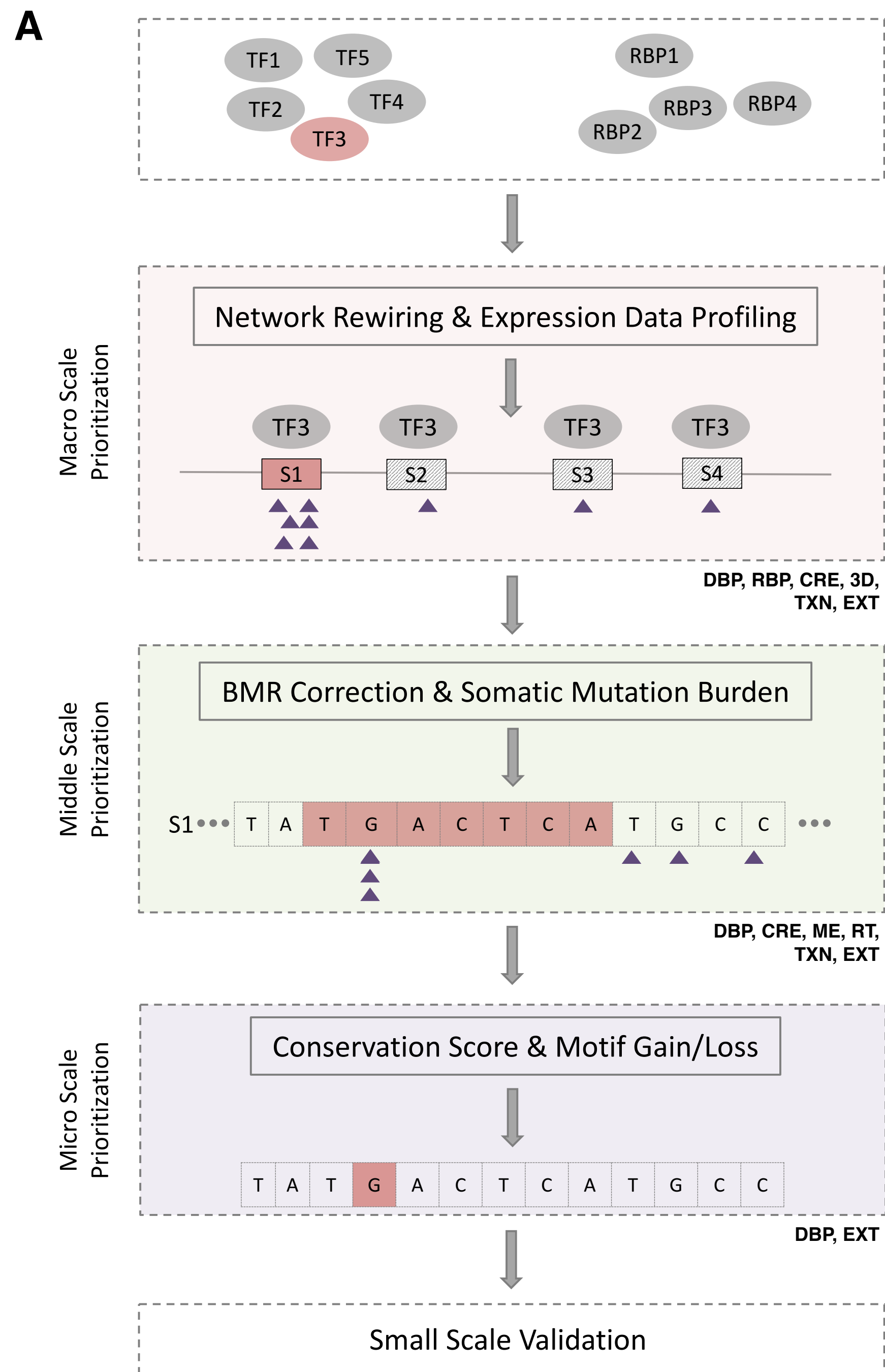

**Figure 5**

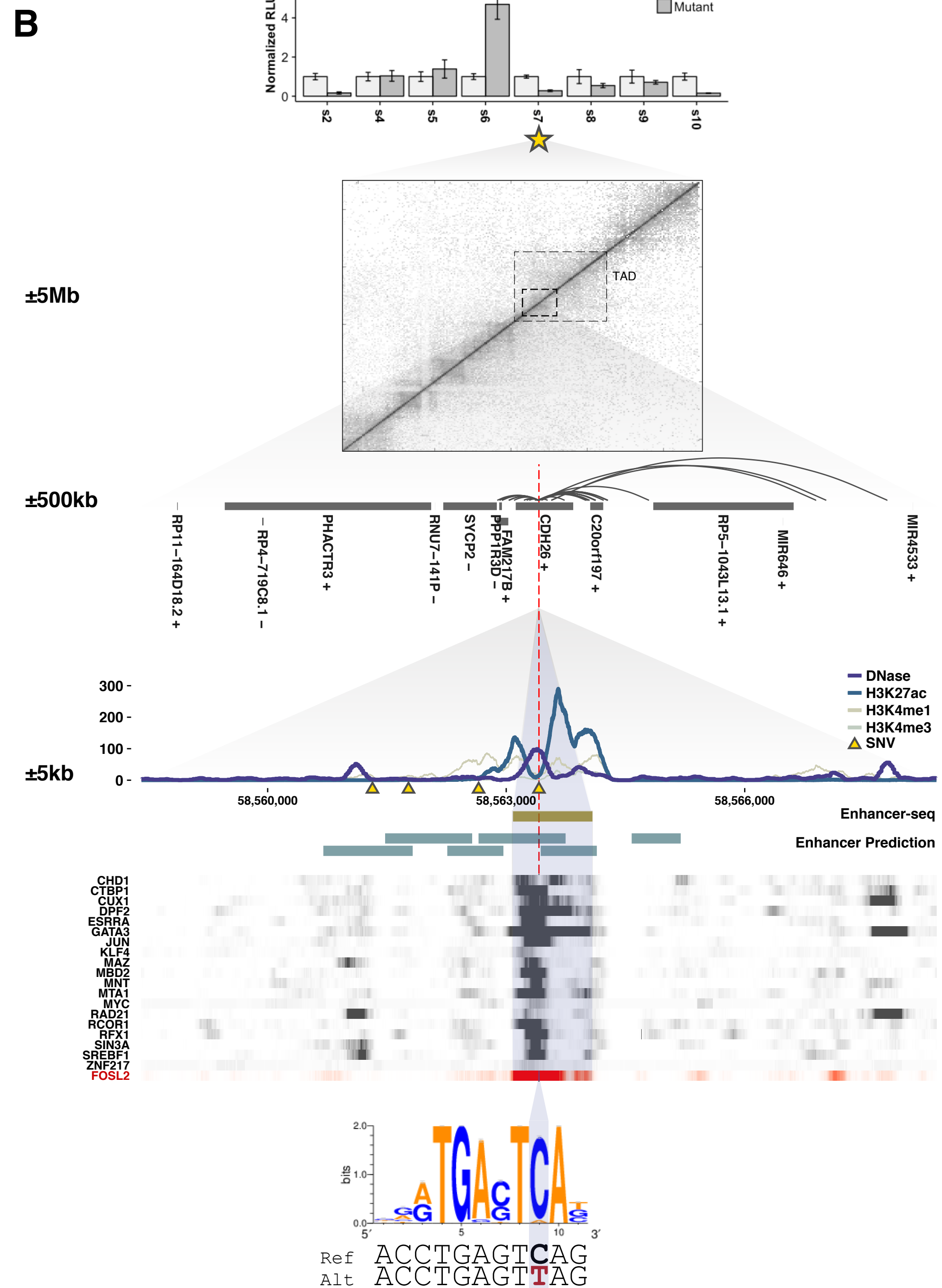
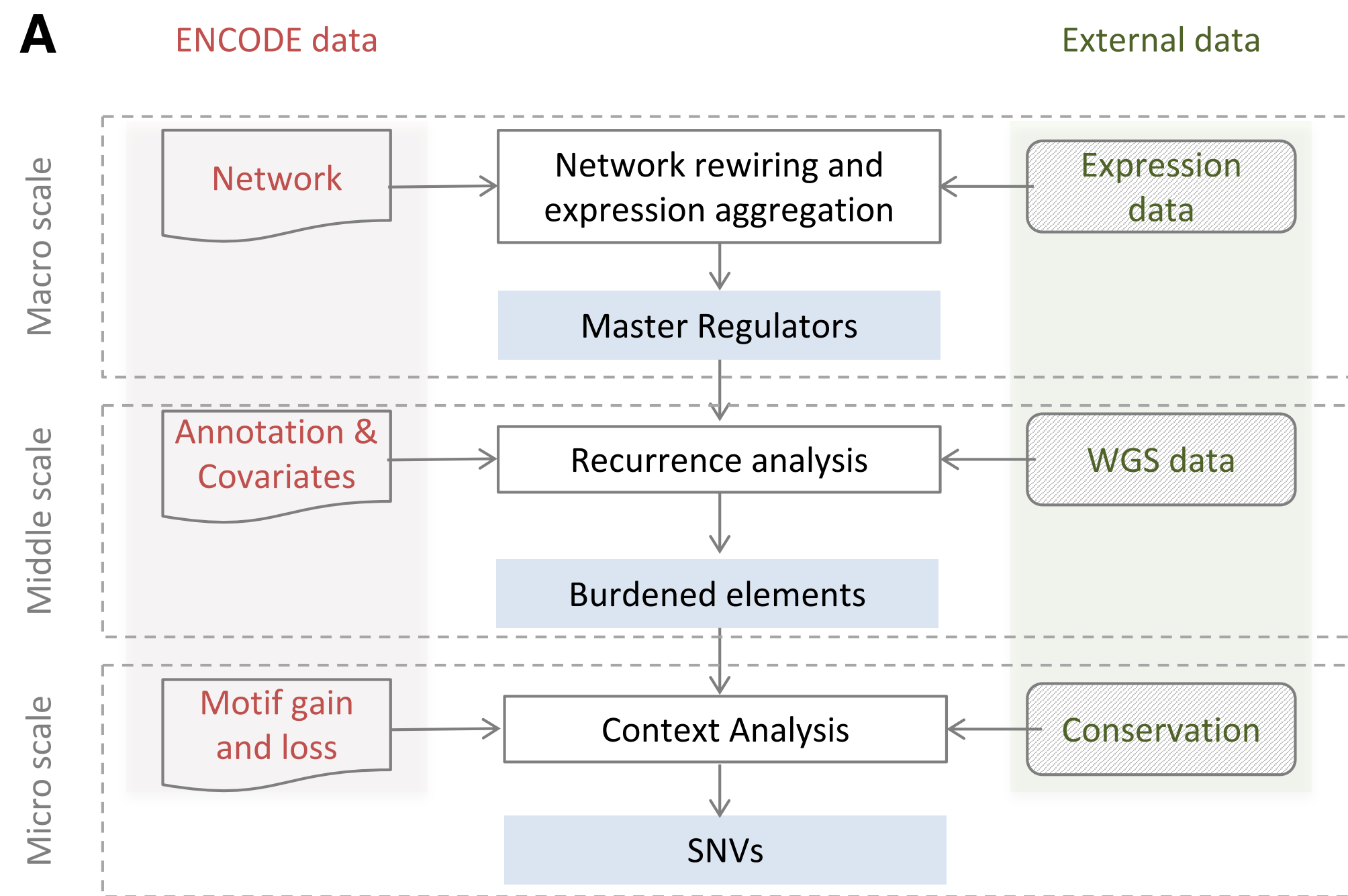

**Figure 5**